



2024 Fall Flag Football Coaches Toolkit

All Divisions (1st / 2nd Grade, 3rd / 4th Grade & 5th / 6th Grade)



CAPITAL CITY FOOTBALL ASSOCIATION

OUR MISSION

Provide our players and their families an unparalleled football experience through exceptional coaching, elite programming and an unwavering commitment to safety.

INTENT OF THE COACHES TOOLKIT

Provide guidance to you coaches on everything you need to know for the upcoming year to ensure a successful and safe upcoming season. And also...

THANK YOU

For your commitment to the program and the kids; without you there wouldn't be a Capital City Football Association!

WHATS INSIDE

Coaching Principles

Season & Gameday Logistics

Flag Field Layout

1/2 Overview + Plays

3/4 Overview + Plays

5/6 Overview + Plays

Playing Time Grid (5/x5)

Rosters & Coaches



CAPITAL CITY FLAG FOOTBALL COACHING PRINCIPLES

MANAGE THE TEAM BUT WE COACH EVERYONE ON THE FIELD

We are focused on building a football community. Encourage and support all kids on the field not just your own. You never know when they might be on your team!

COACHES ATTITUDE AND ACTIONS ARE REPLICATED BY THE PLAYERS

How you act is how the players act. Keep it positive, keep it fun! Don't be remembered as "that coach" this season

EVERYONE PLAYS, EVERYONE IS SAFE AND EVERYONE SHOULD SIGN UP NEXT YEAR

There is a lot going on in everyone lives, football should be a moment of joy for the players and their families this fall. Remember everyone on the field is still in elementary school, no one is getting college scholarships this season!

.



SEASON & GAME DAY LOGISTICS

SPORTS ENGINE: Rosters and schedules will be stored in the sports engine app. Parents are encouraged to use the app to notify of attendance / absence on game days and for communication with the coaches.

SEASON SCHEDULE

League will operate on a 10 game schedule with games on Sunday and Tuesdays (or Thursdays) starting on **September 8th** ending on **October 13th**

- *Sundays: 4:00pm – 7:00pm*
- *Tuesdays / Thursdays: 6:00pm – 7:00pm (1/2 & 3/4 Grades Division Only)*

GAME SCHEDULE

- **1/2 & 3/4 Grades Divisions - Game time will be 60 minutes:**
 - *20 Minute Practice / Drills*
 - *40 Minute Games (2 - 20 minute halves)*
- **5/6 Grade Division – Game time will be 90 minutes**
 - *2 – 40 minute games*

PRACTICE DRILL GUIDANCE / SUGGESTIONS

- Hand-off drills
- Running Passing Routes
- Practice Run plays
- Pulling flag
- QB Center Snapping
- Stretching / Warmups

FIELD EQUIPMENT

Equipment Bag: Each field will have an equipment bag with four balls and flags for both teams on game day. **PLEASE RETURN THE BAG TO THE CENTER OF THE FIELD** with the balls and flags at the end of each game.

First Aid: There will be a first aid kit at the middle of the greater field to be used by all teams

PLAYER EQUIPMENT

- Players are recommended to wear mouth pieces during all games and practices.
- Players must have shirts tucked in pants and flags properly displayed.
- Flags may not be wrapped around belt loops or the belt.
- Each player must wear their association provided jersey.
- Athletic shoes and molded spikes are permitted. No metal spikes are allowed.



FIELD LAYOUT (4:00 – 5:15 PM)

Field Sponsors will be updated prior to the start of the season

LOCATION: All games will be played at CDH Turf Field (550 S Albert St, St Paul, MN 55116)

FIELD NUMBERS

1st & 2nd Grade
Fields 5 - 8

3rd & 4th Grade
Fields 1 - 4

LINE MARKERS

— Starting Line —

— 1st Down —

— Goal Line —

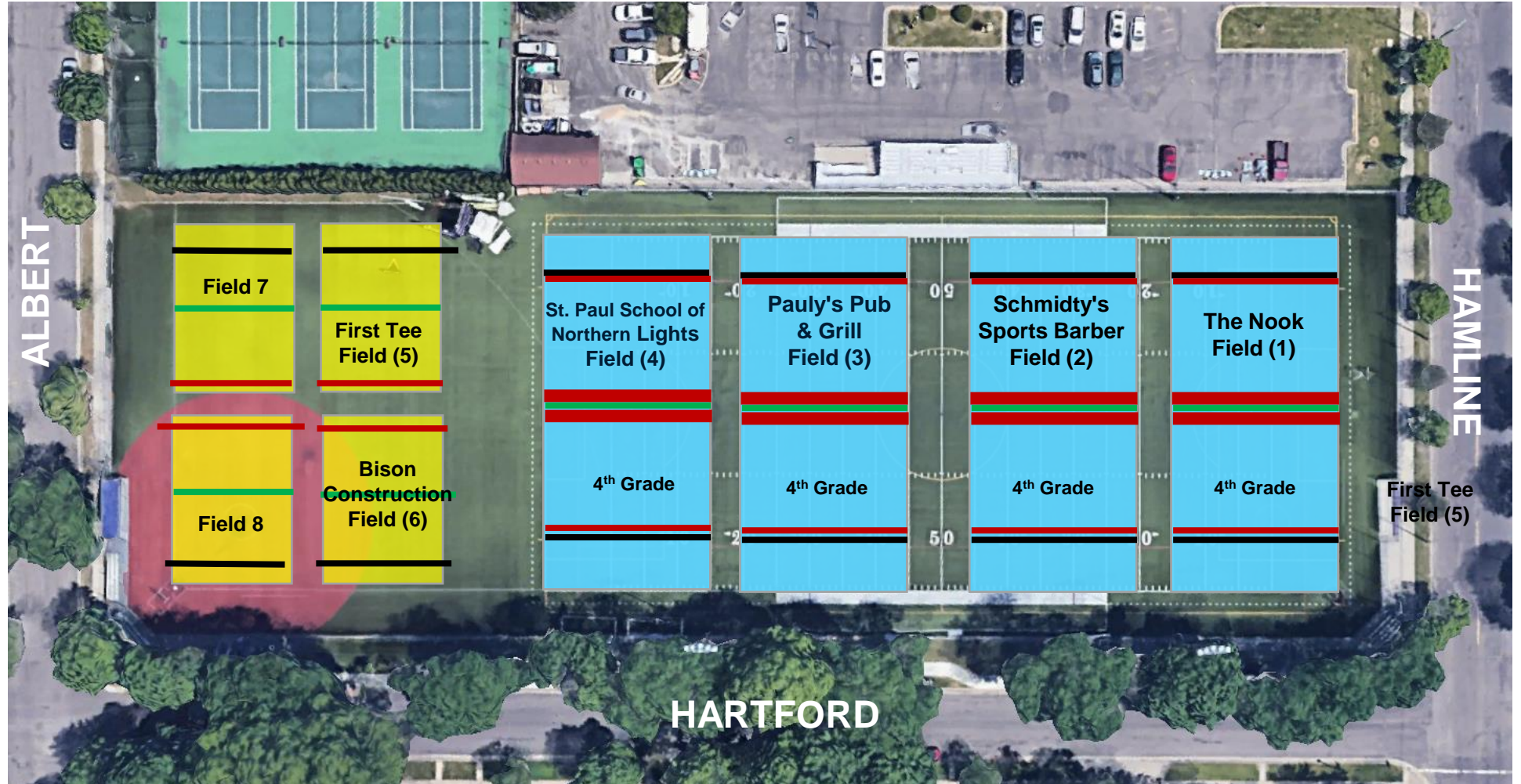



1ST / 2ND GRADE FIELD LAYOUT (4:00 – 5:15 PM)

LOCATION: All games will be played at CDH Turf Field (550 S Albert St, St Paul, MN 55116)

- Playing fields are located at the east end of the field
- Fields are 25 yards long and 20 yards wide
- Play will be in one direction as shown by the arrows for each field, to ensure player safety
- First down line in the middle of the field (Green Line)

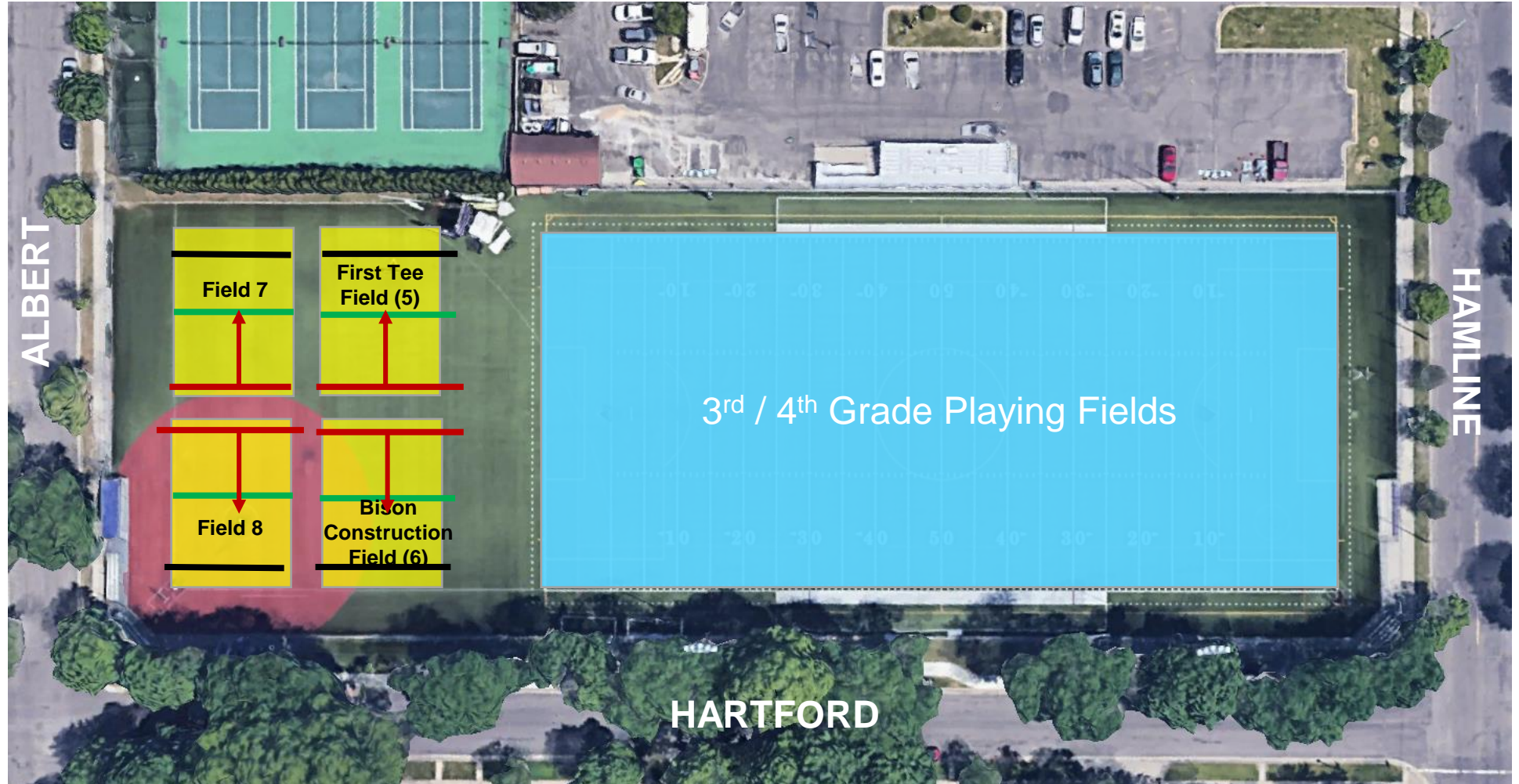



1ST AND 2ND GRADE GAME PLAY RULES

GENERAL OVERVIEW

- 6x6 Team Play
- Field is 25 yards in length. 1st down is at the 10 yard marker
- 4 downs for a first/touchdown
- Any turnover on downs, reset ball to starting line
- A fumble during the play results in a dead ball at the spot of the fumble, with the team keeping possession
- Fumble on the QB / Center exchange results in a redo
- A turnover by int, possession is gained where tackled

SCORING

- Td = 6;
- Extra point = 1 pt from 5, 2 pts from 10;

OFFENSE

- Every play starts with a snap
- Offensive linemen are not eligible receivers
- No QB sneaks (up the middle). QB sweep is permitted
- Players running the ball are not allowed to lower or butt their head, use a straight arm, use a stiff arm, hurdle another player or run directly at an opposing player or defend against defenders reaching for their flags.
- Pass plays have to be announced.

DEFENSE

- Defensive players cannot cross the line of scrimmage unless it is determined the play is a pass or the ball is outside the “tackle box”, then only the defensive ends are allowed to rush the passer. .
- The defense may not intentionally impede the progress of the ball carrier by holding, tripping, tackling or hitting.
- No rushing the QB during pass plays

REFS

- Coaches to act as refs

STANDARD FORMATION

This guidance, feel free to build out formations within the guidance of the rules

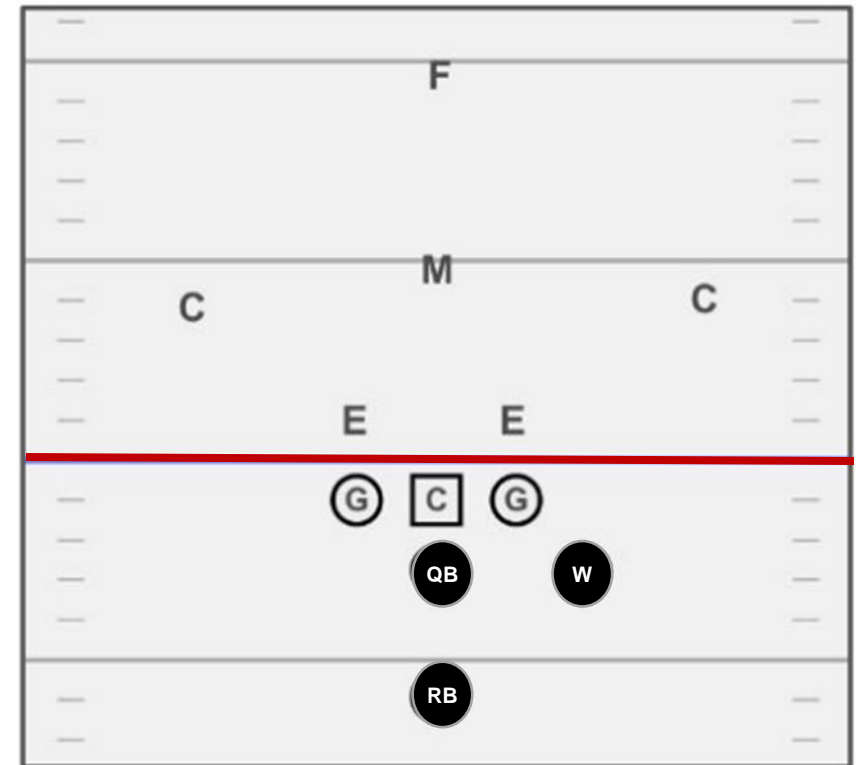



RUNNING PLAYS

These are the running plays that every team should run throughout the season

RUN RIGHT

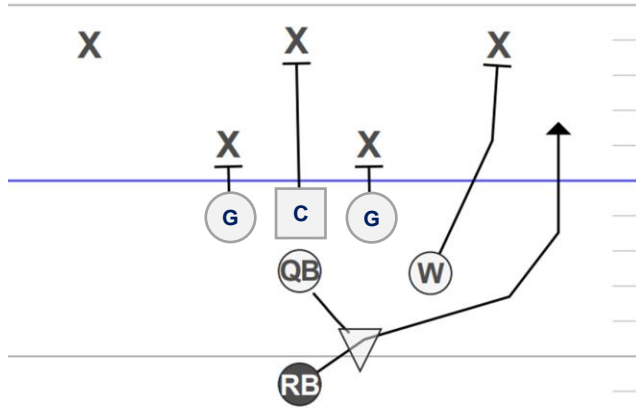

QB SWEEP RIGHT

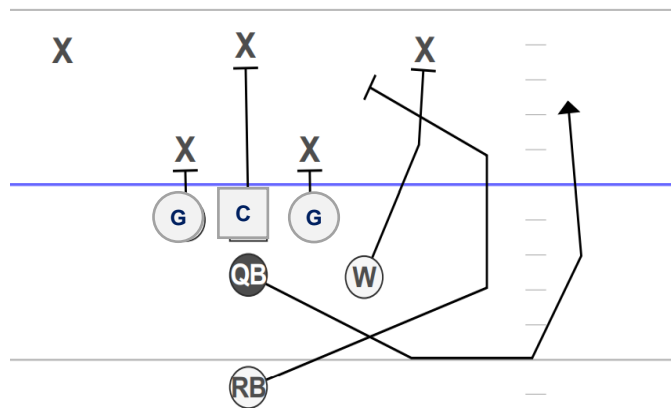

JET SWEEP RIGHT

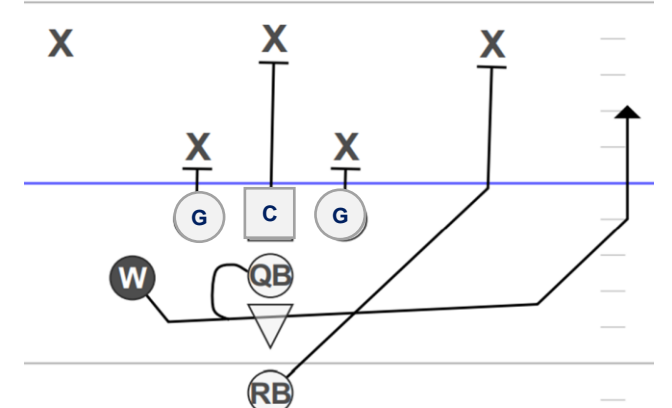

RUN LEFT

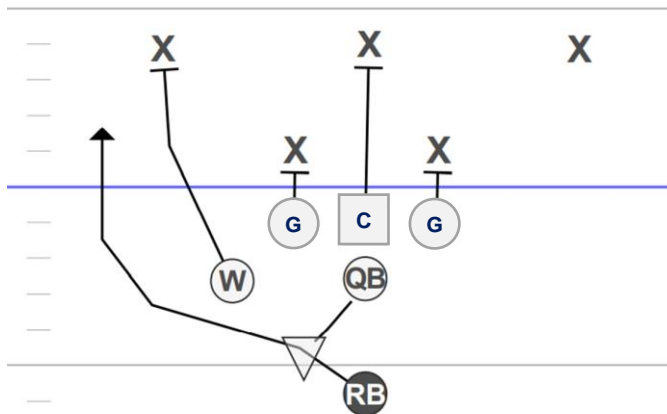

QB SWEEP LEFT

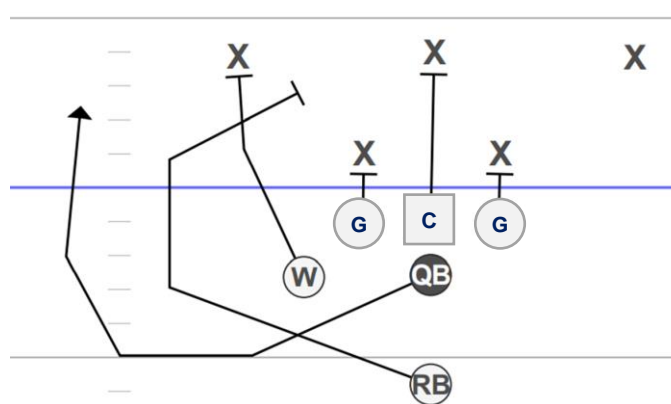

JET SWEEP LEFT

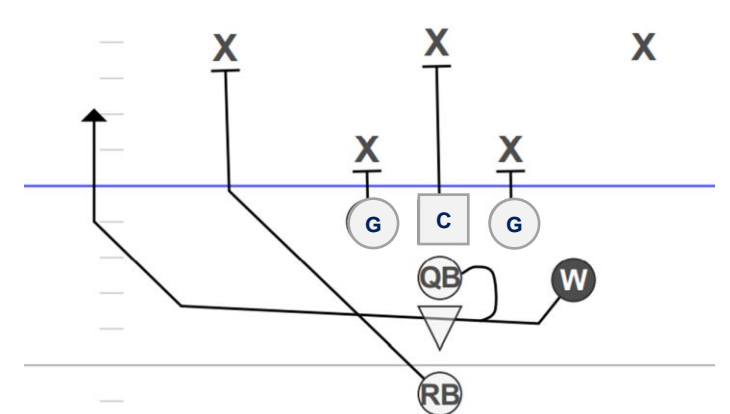



PASSING PLAYS

These are the passing plays that every team should run throughout the season

BOOT RIGHT

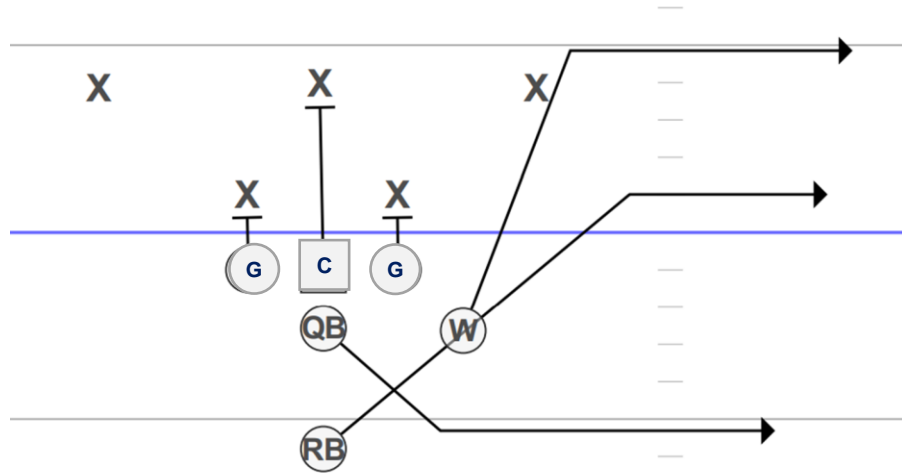

BOOT LEFT

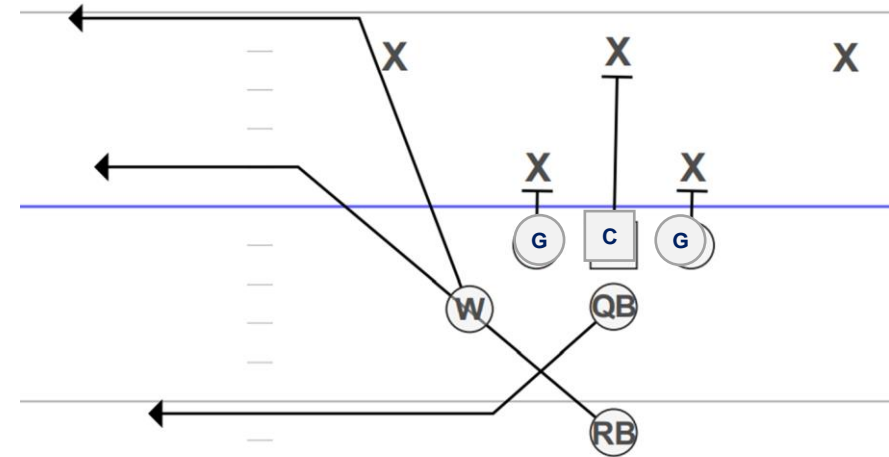



3RD / 4TH GRADE FIELD LAYOUT (4:00 – 5:15 PM)

LOCATION: All games will be played at CDH Turf Field (550 S Albert St, St Paul, MN 55116)

Field Sponsors will be updated prior to the start of the season

- Fields are 25 yards wide and the width of the football field
- Play will be in both directions, with endzones on both ends of the field
- First down line in the middle of the field (Green Line)
- No run zones are 3 yards before the first down and the end zone (Red Lines)
- Teams will start with the ball 5 yards outside of their endzone

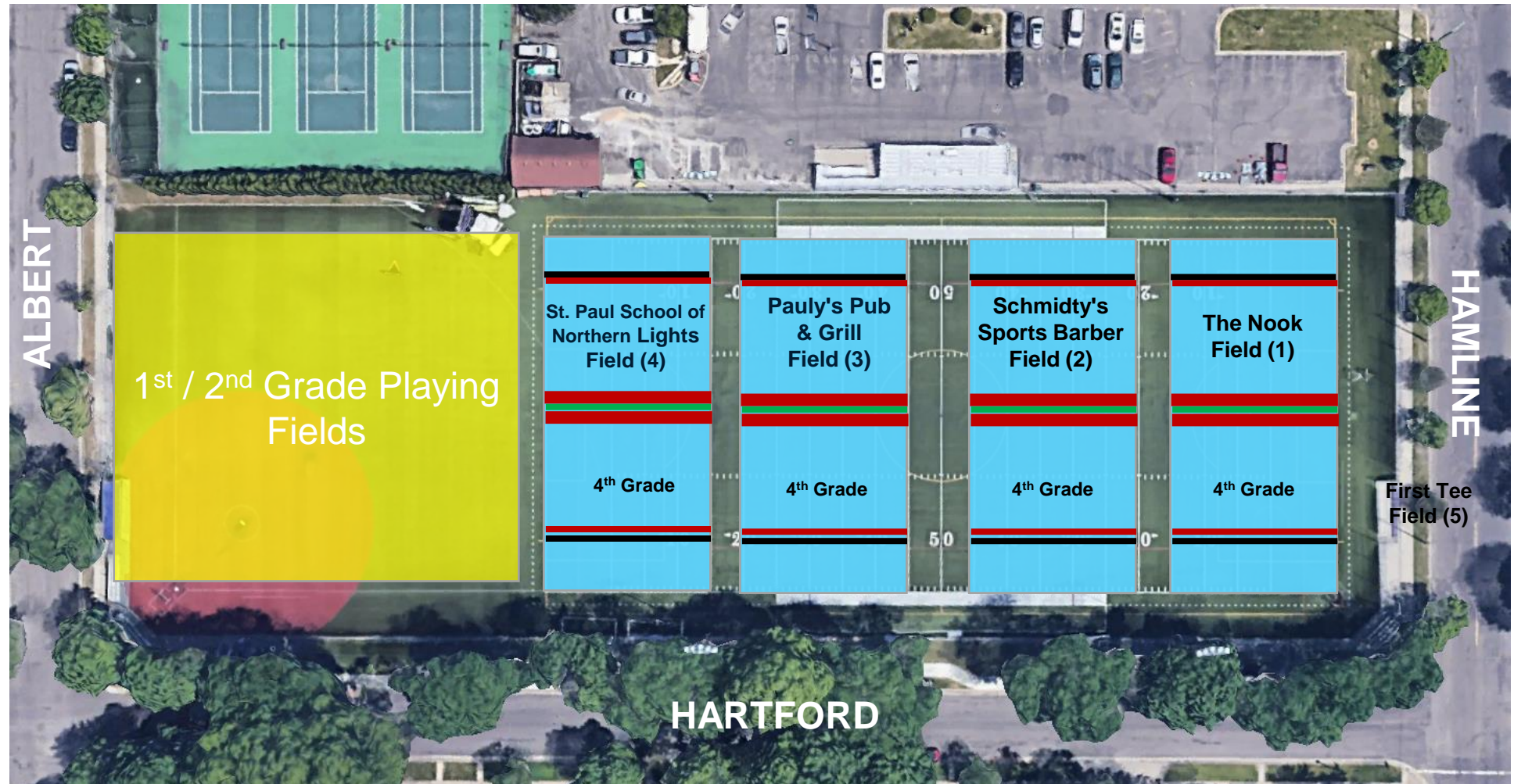



3RD AND 4TH GRADE GAME PLAY RULES

GENERAL OVERVIEW

- 5x5 Team Play
- Field is the width of the football field, 1st down is middle of the field
- 4 downs for a first/touchdown
- Any turnover on downs, reset ball to starting line.
- A turnover by int, possession is gained where tackled
- A fumble during the play results in a dead ball at the spot of the fumble, with the team keeping possession
- Fumble on the QB / Center exchange results in a redo

SCORING

- Td = 6;
- Extra point = 1 pt from 5, 2 pts from 10;

OFFENSE

- No blocking
- Every play starts with A snap
- Center is eligible
- Standard fb alignment and motion rules
- Running is legal, but must be a handoff
- Two players need to be lined up on the line to be a legal formation

DEFENSE

- No rushing the QB
- No tackling
- QBs have roughly 5 secs to throw the ball to avoid loss of down (*Coaches should start a count down encouraging the QB to throw the ball*)
- Contact with WR is allowed until ball has is in the air.

REFS

- Coaches to act as refs

STANDARD FORMATION

This guidance, feel free to build out formations within the guidance of the rules

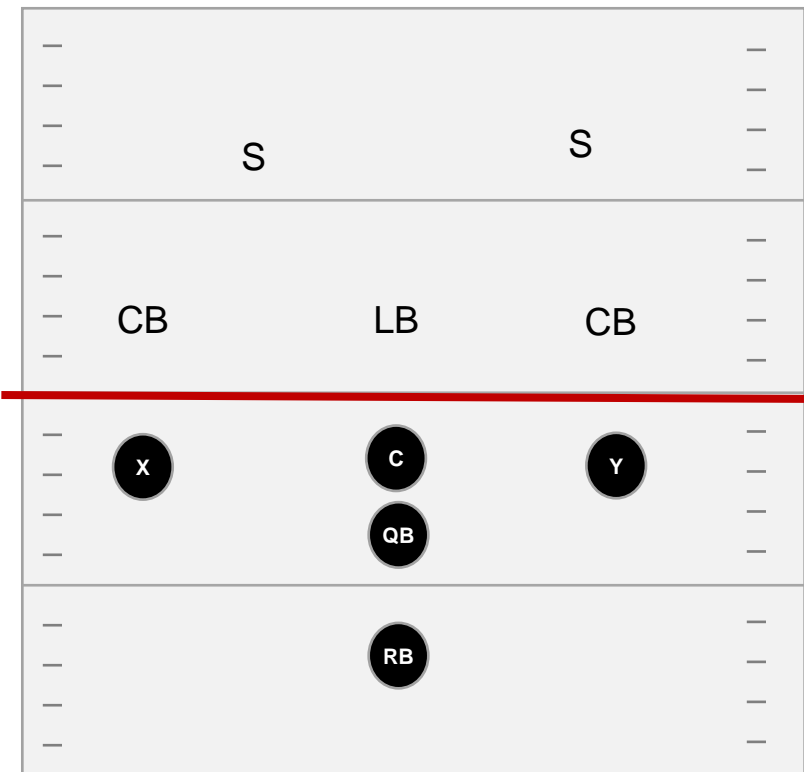



5 ON 5 PASSING PLAYS

These are suggested play but feel free to come up with your own within the rule guidelines

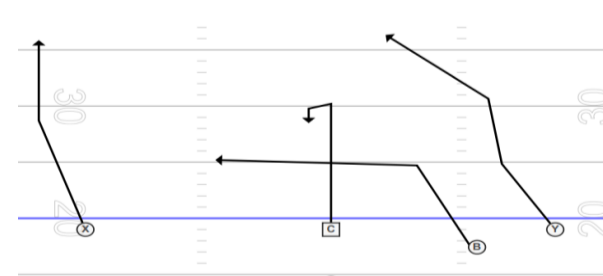
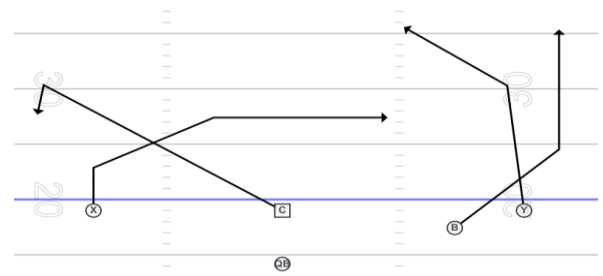
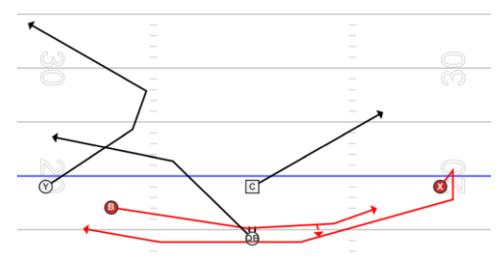
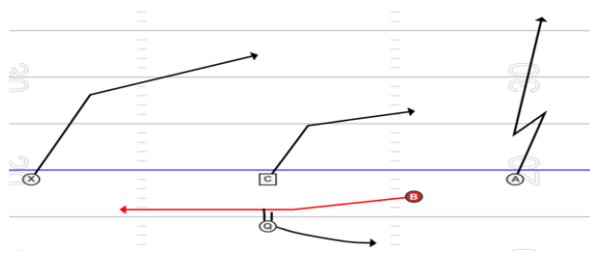
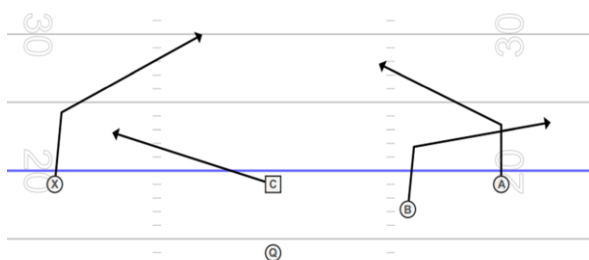
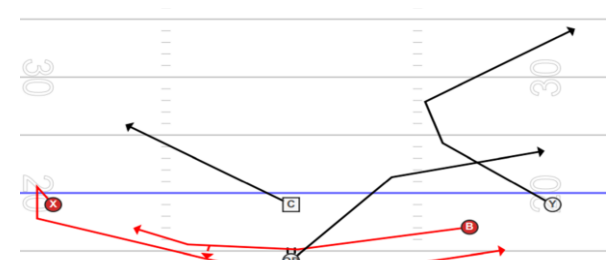
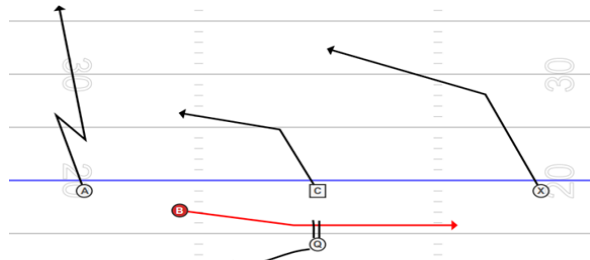
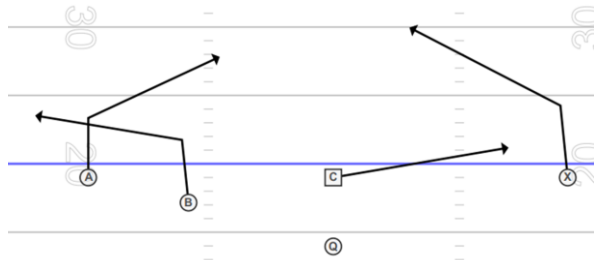



5TH / 6TH GRADE FIELD LAYOUT (5:30 – 7:00 PM)

LOCATION: All games will be played at CDH Turf Field (550 S Albert St, St Paul, MN 55116)

Field Sponsors will be updated prior to the start of the season

- Fields are 25 yards wide and the width of the football field
- Play will be in both directions, with endzones on both ends of the field
- First down line in the middle of the field (Green Line)
- No run zones are 3 yards before the first down and the end zone (Red Lines)
- Teams will start with the ball 5 yards outside of their endzone

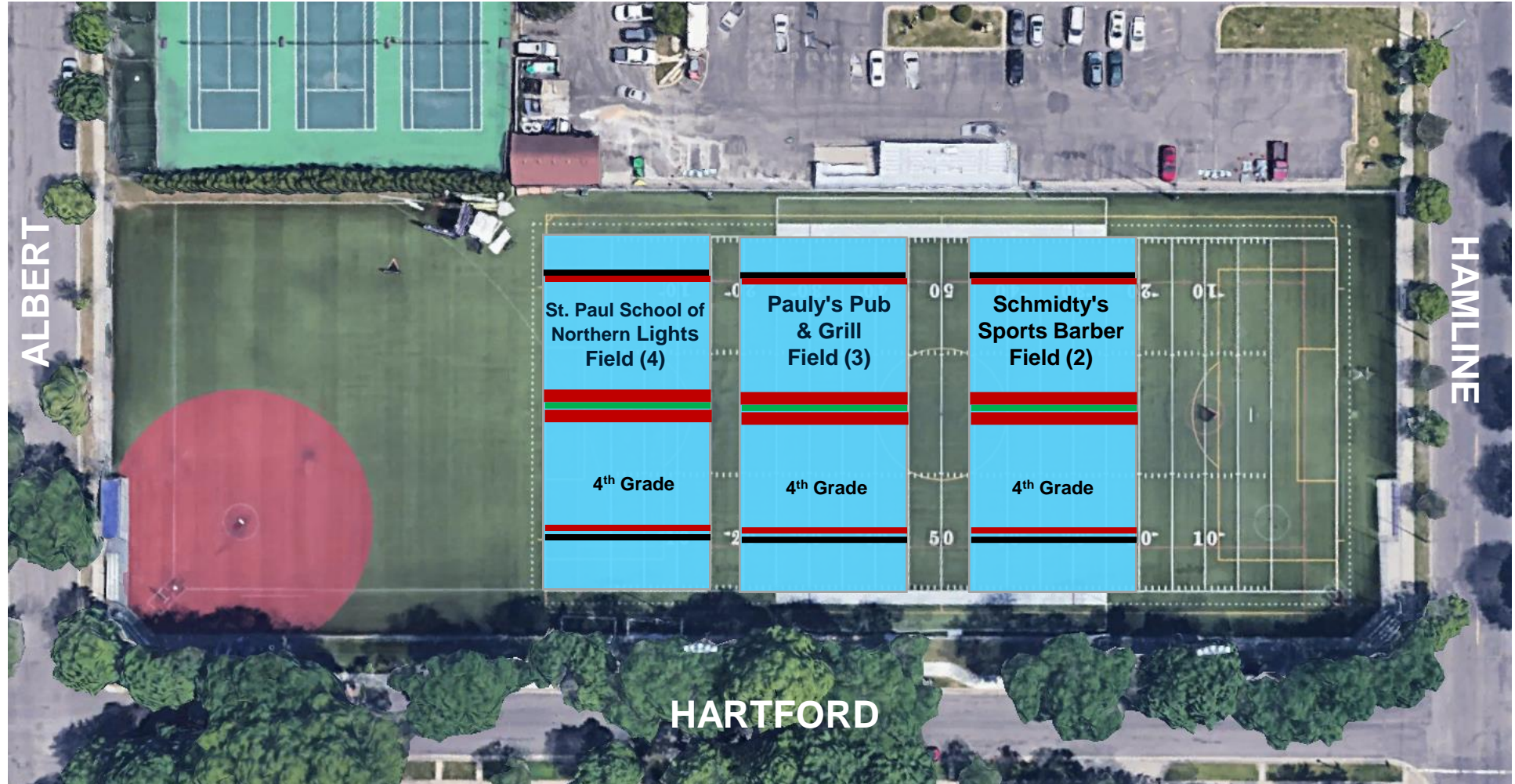



5TH / 6TH GRADE GAME PLAY RULES

GENERAL OVERVIEW

- 5x5 Team Play
- Field is the width of the football field, 1st down is middle of the field
- 4 downs for a first/touchdown
- Any turnover on downs, reset ball to starting line.
- A turnover by int, possession is gained where tackled
- A fumble during the play results in a dead ball at the spot of the fumble, with the team keeping possession
- Fumble on the QB / Center exchange results in a redo

SCORING

- Td = 6;
- Extra point = 1 pt from 5, 2 pts from 10;

OFFENSE

- No blocking
- Every play starts with A snap
- Center is eligible
- Standard fb alignment and motion rules
- Running is legal, but must be a handoff
- Two players need to be lined up on the line to be a legal formation

DEFENSE

- No rushing the QB
- No tackling
- QBs have roughly 5 secs to throw the ball to avoid loss of down (*Coaches should start a count down encouraging the QB to throw the ball*)
- Contact with WR is allowed until ball has is in the air.

REFS

- Coaches to act as refs

STANDARD FORMATION

This guidance, feel free to build out formations within the guidance of the rules

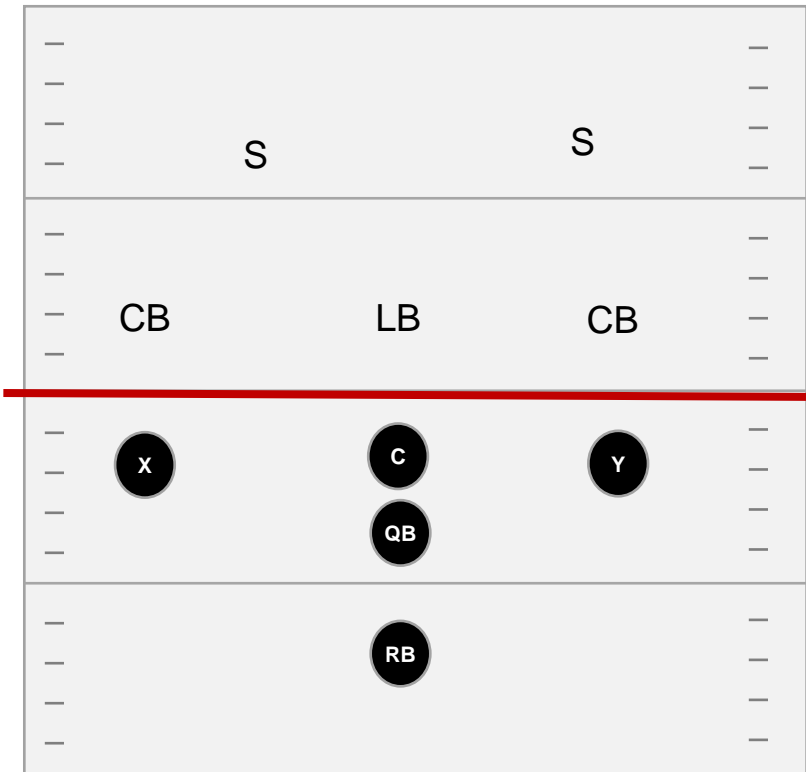



5 ON 5 PASSING PLAYS

These are suggested play but feel free to come up with your own within the rule guidelines

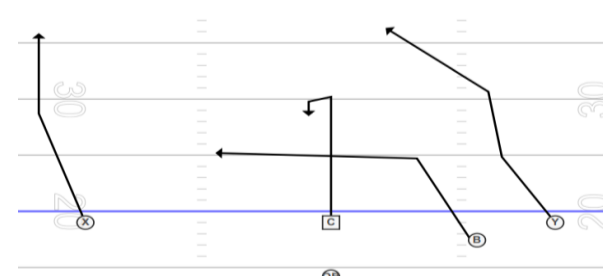
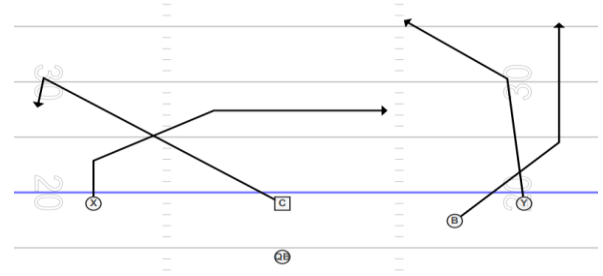
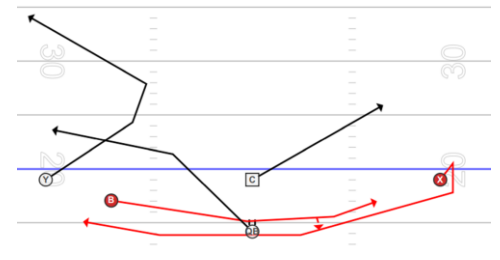
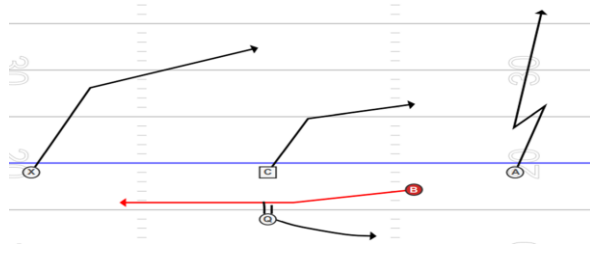
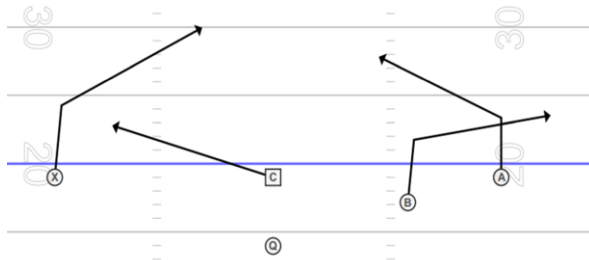
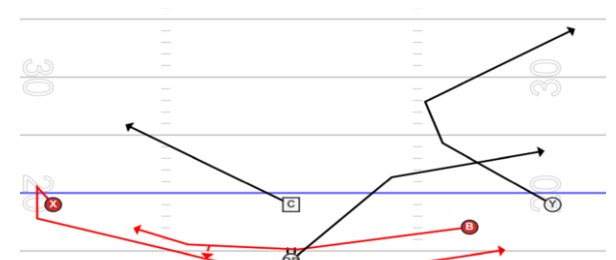
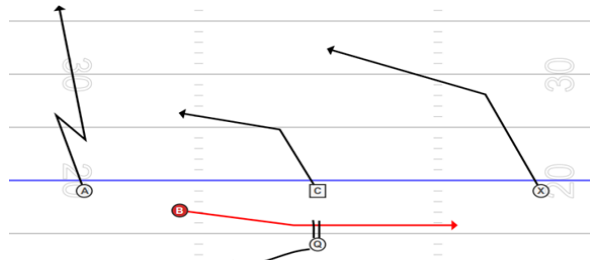
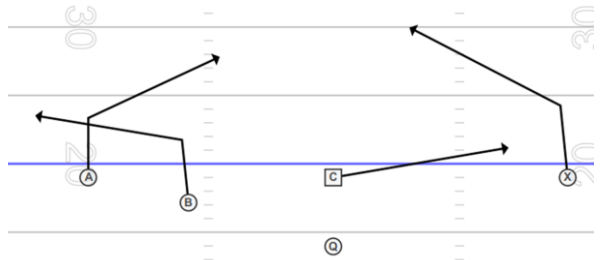



5x5 Playing Time Grid



5X5 – 5 PLAYER GRID

Everyone has equal playing time plays every position. Here is a suggested 5 Player Grid for 5x5

5 Player Grid		1	2	3	4	5	6	7	8	9	10					
	PLAYER	<i>Off</i>	<i>Def</i>	<i>Off</i>	<i>Def</i>	<i>Off</i>	<i>Def</i>	<i>Off</i>	<i>Def</i>	<i>Off</i>	<i>Def</i>	TD	TD Pass	XP	2pt	Int
QB 1		QB	SS	X	CB right	RB	LB	Y	CB left	C	FS					
QB 5		X	CB right	RB	LB	Y	CB left	C	FS	QB	SS					
QB 4		RB	LB	Y	CB left	C	FS	QB	SS	X	CB right					
QB 2		C	FS	QB	SS	X	CB right	RB	LB	Y	CB left					
QB 3		Y	CB left	C	FS	QB	SS	X	CB right	RB	LB					
		Touchdowns			XP	2PT										
	Team															
	Opponent															<input type="checkbox"/>



Rosters and Coaches



1/2 FALL FLAG – ROSTERS AND COACHES

Team 1 Badgers	Molly Jeff	Perkins Lepley	
Teagan	Little	Highland Catholic	2nd
Samuel	Perkins	Highland Catholic	1st
Thomas	Schumacher	Highland Catholic	2nd
Max	Lepley	Highland Catholic	2nd
Benjamin	Olson	Highland Catholic	1st
Lennon	Kertis	Highland Catholic	1st
James	Sweeney	Highland Catholic	1st
Sam	Quayle	Highland Catholic	2nd

Team 4 Huskers	Jeff Stephen	Zajac Nesvig	
Harrison	Zajac	Nativity	2nd
Frank	Murphy	Nativity	1st
Max	Nesvig	Nativity	1st
John	Lohmer	Nativity	2nd
Liam	Anderson	Chelsea Heights	2nd
Adhan	Barnes	Adams	2nd
Henrik	Wolf	Adams	2nd

Team 7 Hawkeyes	Nicholas Tim	Wanka O'Neil	
Nathan	Wanka	Nativity	2nd
Seamus	O'Neil	Nativity	1st
Cole	Morrell	Nativity	2nd
Dev	Rhodus	Nativity	1st
Graham	Hoffman	Nativity	2nd
Brooks	Wilson	Nova Classical	2nd
Felixiano	Rivera - Valdez	Riverview West Side S	1st

Team 2 Wildcats	Kayla Colin	Bakken Perkins	
Rowan	Talerico	Horace Mann	2nd
Miles	Samms	Horace Mann	1st
John	Kilgriff	Horace Mann	1st
Tate	Gustafson	Horace Mann	1st
Walter	Feliciano	Horace Mann	1st
Henry	Perkins	Horace Mann	2nd
Desmond	Stuart	Horace Mann	2nd

Team 5 Bruins	Ian Michael	Davy Brown	
Ralph	Davy	Nativity	1st
Thaddeus "Te"	Brown	Nativity	2nd
Sam	Willer	Nativity	2nd
Daniel	Johnson	Nativity	1st
Wesley	Bratzel	Christ Household of F	2nd
Asa	McElroy	St. Thomas More	1st
Joshua	Benke	St. Thomas More	1st
Emmett	Larson	St. Thomas More	1st

Team 8 Wolverines	Anthony Melissa	Blake Hanrahan	
Vincent	Tuominen	SPA	2nd
Anders	Blake	SPA	1st
Larelle	MCCLARRO	St Rose of Lima	2nd
Baxter	Wall	Randolph Heigh	1st
Jay	Vrieze	Randolph Heigh	1st
Ellington	Beckmann	TCGIS	2nd
Brooks	Oja	TCGIS	2nd
Niklas	Binkowski	TCGIS	2nd

Team 3 Spartans	Dustin Gary	Sadnick Lingen	
Theodore	Sadnick	Horace Mann	2nd
Jameson	Totzke	Horace Mann	2nd
Alexandra	Cruz	Horace Mann	1st
Louie	Nelson	Horace Mann	1st
Charles	Bouslog	Horace Mann	1st
Gunnar	Johnson	Holy Spirit	1st
Coen	Lingen	Minnehaha Academy	2nd
Everett	Johnson	Horace Mann	2nd

Team 6 Buckeyes	Kevin Peter	Ehlers Nativity	
Peter	Ehlers	Nativity	2nd
Ryan	Nair	Nativity	2nd
Mason	Hickey	Nativity	1st
Max	Elfritz	Expo	1st
Sawyer	Hudalla	Expo	2nd
Cohen	Stapleton	Capital Hill	2nd
Freddie	VanHeuvele	Capitol Hill	2nd



3/4 FALL FLAG – ROSTERS AND COACHES

Team 1 Chiefs	James	Parker	
	Ryan	Crain	
	Rachel	Anderson	
Noah	Jensen	Nova	4th
Knox	Parker	Nova	4th
Clark	Crain	Nova	3rd
Kieran	OHara	Nova	3rd
Clement	Griffin	Nova	4th
Willa	Anderson	Nova	4th
Kiera	Anderson	Nova	4th

Team 2 Vikings	Thomas	Marrinan	
	Zach	Marsh	
Blake	Resnick	Mendota Elementary	4th
Isaac	Dorn	Mendota Elementary	4th
Brady	Mitsch	Mendota Elementary	4th
Zachary	Johnson	Mendota Elementary	4th
August	Brainard Marsh	Horace Mann	3rd
David	Marrinan	Horace Mann	3rd
Henry	Sampson	Capitol Hill Magnet	3rd

Team 3 Packers	Andrew	Miller	
	Mike	Butler	
Luke	Halderman	Holy Spirit	3rd
Jack	Miller	Holy Spirit	3rd
Catherine	Gilbert	Holy Spirit	3rd
Evelyn	Bazal	Holy Spirit	3rd
Liza	McDowell	Holy Spirit	4th
Harriet	Butler	Holy Spirit	3rd
Isla	Doyle	Holy Spirit	3rd
Madeleine	Thompson	St Thomas More	4th

Team 4 Dolphins	Charlie	Peterson	
	Joshua	Layfield	
William	Miles	Horace Mann	4th
Peter	Layfield	Horace Mann	4th
Xavier	Anderson	Horace Mann	4th
Greer	Peterson	Horace Mann	3rd
Henry	Thiboldeaux	Expo Elementary	4th
Cieran	McGuire-Lee	Saint Thomas More	4th
Amir	Johnson	Horace Mann	3rd

Team 5 Lions	Pat	Petschel	
	Wesley	Johnson	Visitation
Thomas	Petschel	Visitation	4th
Sammy	Schlueter	Groveland	4th
Sam	Lukasik	Groveland	4th
Reynir	Birkland	Groveland	4th
Abel	Ellason	Nativity	3rd
Hayden	Russell	Nativity	3rd

Team 6 Cowboys	Kenneth	Schramm	
	Miles	Wetzel	Saint Thomas More
Knute	Spaeth	Saint Thomas More	3rd
Kellen	Baker	Saint Thomas More	3rd
Paddy	Blumberg-Junius	Saint Thomas More	3rd
George	Townsend	Saint Thomas More	3rd
Gunnar	Schramm	Saint Thomas More	3rd
Charlie	Huss	Saint Rose of Lima- Ro	3rd

Team 7 Steelers	David	Hansen	
	Devin	Simmons	
Jameson	Vasquez	St. Paul School of N	3rd
Hunter	Larson	Saint Anthony Park	3rd
William	Funk	Nativity	4th
Leo	Morrell	Nativity	4th
Tanner	Oja	TCGIS	4th
Walter	Hansen	TCGIS	4th
Waylon	Simmons	Highland Catholic	4th

Team 8 Bears	Amanda	Taylor	
	Timothy	Frost	
William	Taylor	Jie Ming Mandarin Imn	4th
Malakai	Frost	JJ Hill	4th
Owen	Frank	Randolph Heights	4th
Reid	Croushore	Randolph Heights	4th
Welles	Wiegratz	Groveland	3rd
Adler	Edwards	Groveland	3rd
Zeph	Baer	Groveland	3rd



5/6 FALL FLAG – ROSTERS AND COACHES

Team 1 UNLV	Matthew	Wittmer	
Oscar	Wittmer	Horace Mann	5th
Tommy	Ryan	Horace Mann	5th
Harlan	Feliciano	Horace Mann	5th
Henry	Samms	Horace Mann	5th
Isaac	Samms	Horace Mann	5th
Wesley	Reischel	Horace Mann	5th
Elliot	Goblirsch	Horace Mann	5th

Team 2 - Colorado St.	Dustin	Sadnick	
	Charlie	Peterson	
Cooper	Sadnick	Horace Mann	5th
Leo	Rosas-Aar	Horace Mann	5th
Javier	Cruz	Horace Mann	5th
Evan	Litzenberg	Horace Mann	5th
Edith	Andrianak	Expo	5th
Everett	Peterson	Horace Mann	5th
Collin	Hughes	Horace Mann	5th

Team 3 - Utah St.	Colin	Rooney	
Ailey	Anderson	Nova Classical Academy	6th
Henry	Larson	Nova Classical Academy	5th
Si	Ellason	Nativity	5th
Mark	Frosch	Saint Anthony Park	5th
Crosby	Roney	Twin Cities German immersion	6th
Eli	McKigney	Twin Cities German Immersion	6th
Riley	Huss	Saint Rose of Lima - Roseville, MN	6th

Team 4 - Air Force	Kevin	Heinz	
Francis	Martin	Saint Thomas	5th
Henrik	Spaeth	Saint Thomas	5th
Noah	Quie	Saint Thomas	5th
Calvin	Heinz	Saint Thomas	5th
Logan	Rice	Saint Thomas	5th
Leo	Bickford	Saint Thomas	5th
Myles	Bowman	Capitol Hill	5th

Black - San Diego	Becky	Clifford	
Wyatt	Carlson	Highland Middle	6th
Nevan	Hill	Highland Middle	6th
Aubrey	Ochocki	Highland Middle	6th
Oliver	Willson	Hidden River	6th
Leo	Kopacek	Hidden River	6th
Abe	Clifford	Highland Middle	6th
Liam	Luck	Highland Catholic	5th
Henry	Miller	Highland Catholic	5th

Team 6 - Nevada	Kevin	Rank	
	Timothy	Frost	
Oliver	Frost	Highland Midd	6th
William	Perkins	Nativity of Our	6th
ALTAN	PETERSON	Highland mid	6th
Morgan	Cha	Highland Midd	6th
Charles	Warren	Highland Midd	6th
Finn	Parr	SPA	5th
George	Rank	SPA	5th



9/12 FIELD LAYOUT (GAME 2)

Key

**1st & 2nd Grade
Fields 5 - 8**

**3rd & 4th Grade
Fields 1 - 4**

Parking

Exact field locations will be indicated by the sandwich boards

