

2018 NW Juniors



Hosted by NW Juniors VBC

NW Sports Hub - Centralia

March 10 & 11 - 2018

2018 NW Juniors Spring Classic Tournament

For Team Orders Contact Tony Miranda: tony@volleyballnw.com

OFFICIAL VOLLEYBALL OF NW JUNIORS VOLLEYBALL CLUB

The Baden Perfection® 15-0™ Volleyball



PERFECTION
33% THICKER LEATHER



EXCLUSIVE COVER

The Perfection's exclusive leather cover material is 33% thicker than traditional game balls while its special light weight internal construction keeps the ball at official weight. The result is the softest, truest feeling game ball in the world.



LIGHT-WEIGHT BUTYL BLADDER

Baden's state of the art bladder was developed to accommodate the exclusive leather cover of the Perfection® volleyball. This butyl bladder is the lightest ever used for volleyball. It provides the optimum weight, performance, and durability... a key component of Total Feel Technology™.



VX5E Volleyball

STEALTH SOFT-VALVE SYSTEM™ PATENT PENDING



By re-engineering the entire valve system, including the valve core and valve housing, Baden has softened the entire valve panel creating a 100% consistent feel throughout ALL 18 panels. Combined with the cushioning surrounding the hidden, recessed, undetectable valve, players no longer experience the pain associated with hard, exposed valves found on all other volleyballs. Eliminating the one panel associated with errant digs, sets, and spikes makes Baden the most accurate playing volleyball.



The Athletic Ball Expert™



www.badensports.com

Welcome to our Second Annual Spring Classic Tournament!

2018 NW Juniors Spring Classic Tournament

The 2018 Spring Classic Tournament is an open entry tournament for teams looking for an alternative travel tournament that is not a National Qualifier. The tournament is for Open level and Club level teams. The tournament is held at the NW Sports Hub -- a 14 court facility in Centralia.

There will be two rounds of pool play, followed by playoffs. Saturday will be the first round of pool in the morning-afternoon, followed by the beginning of a second round of pool. Sunday will be the completion of the second round of pool and all of the playoff matches. The tournament format will be set up so that on Sunday, the U14, U16, and U18 Gold finals will be played consecutively on Center Court. All teams will play pool play matches on Sunday and have tournament play Sunday afternoon.

Hopefully those of you that have opted to play in our event this season have an enjoyable experience and spread the word so that our event can continue to grow.

Please take some time to look over this important tournament information – this is all pertinent information vital to the success of this event. We will have a brief coaches meeting before play begins Saturday, but it is important for each of the coaches to become familiar with the tournament policies, as we will not have time to go over all policies at the coaches meeting. We rely on the cooperation of coaches, players, and fans in ensuring that all facility rules and regulations are followed. Please make sure that all persons involved in your team are familiar with all of the rules. We hope you enjoy yourselves this weekend.

Tournament Headquarters:

NW Sports Hub, Centralia, WA

Tournament Director: Tony Miranda, 206-550-6671

Doors will open at 8:00 AM, play will begin at 9:00 AM each day

Admission will be \$5.00 for the weekend; children, students, participants enter free

Tournament Overview:

There are 34 teams in 3 divisions. We are using 10 courts at the NW Sports Hub

U18 Division: 13 Teams

U16 Division: 10 Teams

U14 Division: 10 Teams

General Format:

All teams will play in two rounds of pool play. The second round will play 2-3 matches on Saturday afternoon. All matches will be 2 of 3 sets unless otherwise noted. On Sunday, teams will finish pool play and then move into Sunday playoff brackets. The last scheduled Final Sunday is at 3:30 PM. Details regarding specific formats are listed in this Tournament Handbook.

Puget Sound General Tournament Rules:

Out of region teams are also alerted that the Puget Sound Region has very specific rules regarding teams and tournaments. All of these rules will be in effect this weekend including (paraphrased):

1. No Crock pots or outdoor barbecues are allowed.
2. Pets are not allowed inside the gym.
3. Non-playing siblings and children must be attended at all times.

Please be advised that breaking any of these rules can result in forfeiture of points or your team's removal from the tournament.

2018 NW Juniors Spring Classic Tournament

Game and Forfeit Times:

Please note that matches may begin before the scheduled time. There is **no shared hitting**. The first match of the day and the first match of playoffs are the only matches that will start at the scheduled/published time. Subsequent matches will begin 10 minutes following the conclusion of the previous. Exception: for each team's first match of the day, warm-up will be 5-4-4 (5 minutes of shared court time, 4 minutes for the serving team, 4 minutes for the receiving team. For the rest of the matches each day, warm-up is 2-4-4; **Coaches and referees for the next match are asked to please start the warmup period immediately.** Serving will be done during your four minutes of designated court time. Matches will run ahead of schedule if possible. If a team does not show on time, a forfeit procedure is in place to ensure that the event stays on time. The *first forfeit* set will be 15 minutes following the conclusion of the previous match. The forfeit time for the *second set* will follow 10 minutes later.

Game Balls:

Game Balls will be provided on each court. Our official ball is the **Baden Perfection** game ball. No other ball will be used for scheduled matches.

Protests:

Any formal protest is to be settled on the spot at the time it occurs and before play continues, per USAV rules. All R1 judgment calls are not valid for protest. Any protest will be settled ASAP **by the playing site Day Official in charge**, the tournament director, and one other official or coach who is not involved in the dispute, to be selected by the Day Official. **A protest cannot be filed at the end of a match.** Judgment calls are not protestable.

Officiating:

Team officiating responsibilities are listed in this manual and posted at the tournament headquarters. First round playoff matches are highlighted in the bracket. In the remaining elimination matches, in most cases the Losing team will have officiating duties for the next scheduled match on that court. Each team is responsible to provide the following: R1, R2, Scorekeeper, Assistant Scorekeeper (visual/flip chart), Libero tracker, and two lines persons. Players cannot referee as R1 even though they may better than their coach or referee adult. The only exception is in the U18 pool play rounds: Players can R1 provided the coach is the R2. **Penalties for being late to or missing an officiating assignment: If you are late to your assignment, you will be penalized one point per minute you are late, up to a full match (50 minutes).** If you miss an officiating assignment you will be penalized one match AND be assigned to officiate the next scheduled match that your team is not playing. If you are late to or miss the last match assignment for the day, the same penalty will be assessed on the next day's competition. Officiating assignments are clearly determined throughout the tournament handbook, so there should be no missed officiating assignments. Common courtesy dictates that teams not leave before officiating after their final match / loss on the final day of competition.

Rules of Play:

USAV Domestic Competition Regulations rules will be in effect. All matches in pool play and playoffs will be played 2 of 3 to 25, rally scoring sets as per USAV rules. **For Pool Play, non-deciding sets will be capped at 27.** All deciding sets will go to 15 with no cap, switching sides at 8; the winning team must win by 2 points. Teams will have 3 options at the coin toss: serve, receive, choice of court. **No Caps on Sunday's playoff sets.** In the case of three team pools where teams play 3 sets to 25, no cap – all three sets must be played. The team that wins serve set 1 will also serve set 3; and teams DO NOT switch sides at 13.

Canadian Teams, please be aware of the following USAV rules:

- Teams are allotted 12 total subs per set
- Teams are assigned officiating duties throughout the tournament and must supply R1, R2, Scorekeeping crew, and lines people
- Liberators are permitted to serve in one rotation
- Re-toss on the serve for U14 play.
- No jewelry allowed.

Seeding and Tie-breaking procedures:

In most divisions, in order to simplify the tournament your progressive placing throughout the tournament will be based upon your seed and your finish within your pool; not on how your performance in pool compares to other teams in other pools. This will make it simpler for coaches, fans, players, etc. to figure out exactly where they play next without having to wait for other pools to finish in order to place themselves within the next pool or playoff bracket.

2018 NW Juniors Spring Classic Tournament

Tie Breaking Criteria:

There will be no playoff sets to settle ties. Ties will be broken by the tournament director.

Tie-breaking procedures will be as follows:

- Two-way tie (by match record): Results of the Head to head MATCH
- Three-way tie (by match record): Head to head is not used at any time to break a 3-way tie. Compare the following, in this order:
 - 1) Set win/loss ratio: Total sets won/sets played
 - 2) Points ratio: Total points scored divided by total points allowed
 - 3) Coin Toss

Again, there will be no playoff matches; all ties will be broken by the above criteria.



Souvenir Tee- Shirts & Prizes:

Spring Classic Tournament T-Shirts and other items will be sold at the Fine Designs store within the facility.

Bracket champions will be given a coupon which they can use for a special Champion tee-shirt or for \$13 towards a larger item.

Prizes will be awarded as follows:

- 18 Gold & Silver: \$13 Coupon
- 18 Bronze: Golf Towels
- 16 Gold & Silver: \$13 Coupon
- 14 Gold & Silver: \$13 Coupon

**THANK-YOU FOR PARTICIPATING IN THE
2018 SPRING CLASSIC**

2018 NW Juniors Spring Classic Tournament

FACILITY AND COURT LAYOUT

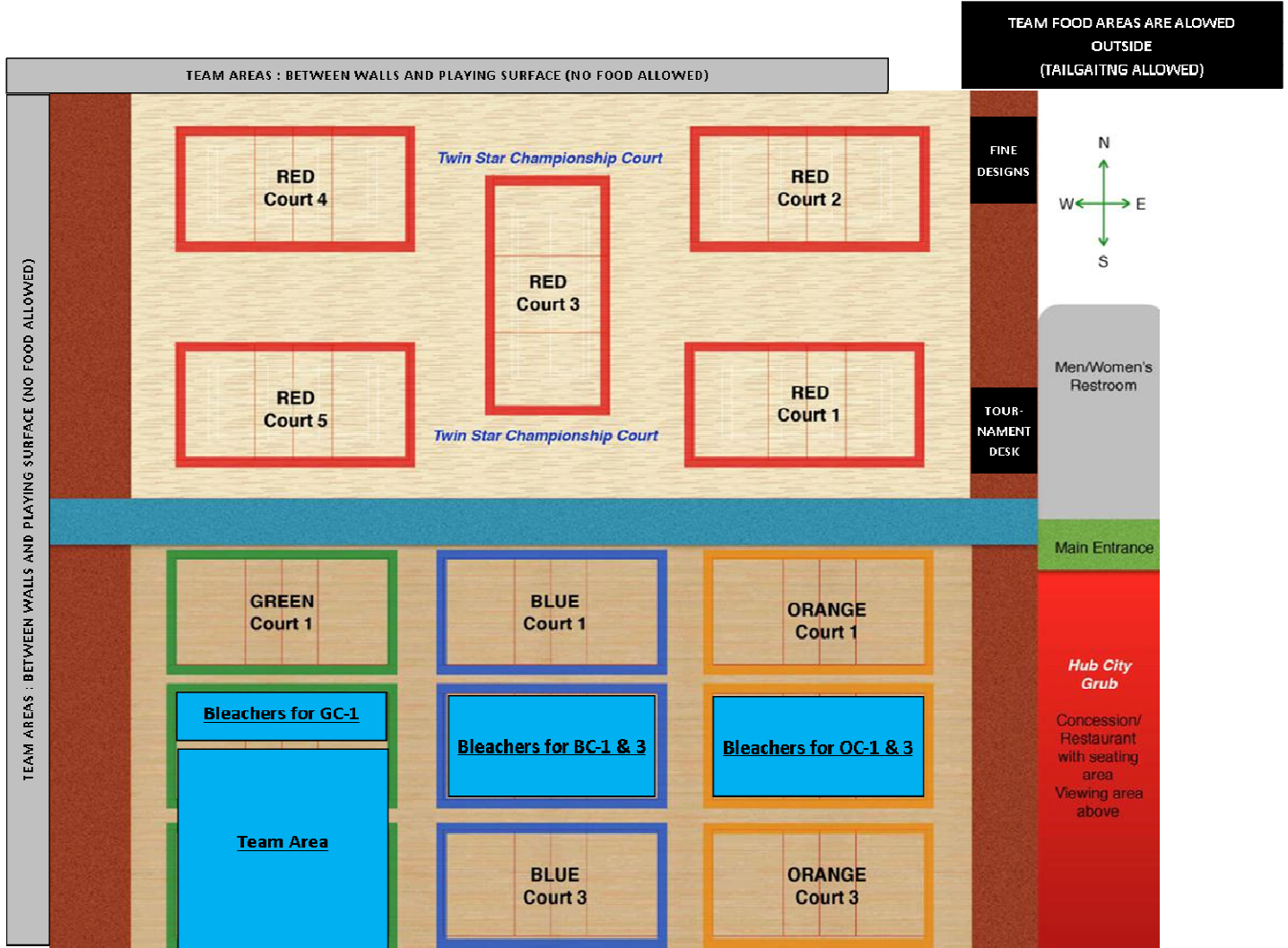

NW SPORTS HUB Guidelines (as published on the tournament page)

Outside Food and beverages: No outside food or beverages are allowed in the facility. The NW Sports HUB has water bottle refill stations, refillable water bottles are allowed in the building (a list of acceptable bottles is posted on the tournament page).

The Northwest Sports Hub strives to provide its guests with a safe, comfortable, and enjoyable atmosphere. Guests interfering with other guests' ability to enjoy the event including using foul or abusive language or inappropriate gestures may be subject to eviction. Guests appearing to be under the influence of an illegal substance may be evicted from the facility and turned over to the authorities.

All Guests must maintain reasonable and appropriate behavior at all times. Guests using offensive language or engaging in disorderly conduct may be ejected from the facility and may be subject to arrest. Ejected Guests will not receive a refund for their tickets or be compensated in any way for their loss. Please refer to our tournament website for a link to the entire list of the guidelines at the NW Sports Hub.

We ask the coaches cooperation in enforcing the rules. It is very important that you inform your players, parents, guests, and coaches of these rules – especially those regarding food, drink and behavior.

Penalties for Food, drink, or gym rule violations:

Penalties for each violation of the above stated rules will be as follows: 15 points for a set to 25, 8 points for a set to 15. The penalty will be assessed at the start of their next scheduled set. Any person associated with a club or team can be held responsible for a violation. Penalties will be assessed by the Day Official and are not protestable.

2018 NW Juniors Spring Classic Tournament

**U18
TOURNAMENT**

2018 NW Juniors Spring Classic Tournament

U18 ROUND 1 POOL PLAY

RED Court 2 POOL A		RED Court 1 POOL B		ORANGE Court 1 POOL C		ORANGE Court 3 POOL D	
1	Club Lokahi 18-1 (EV)	1	OPVBC 18 Supreme (PS)	1	NW Jrs 18 UA Blue (PS)	1	Ignite 18-1 (PS)
2	I Dig It Fusion 17 (CA)	2	West Coast VBC 18's (CA)	2	Rain City 18 (CA)	2	Club Lokahi 18-2 (EV)
3	EV-VBC 18 Katie/Elisa (PS)	3	206vb18 (PS)	3	Club Lokahi 16-1 (EV)	3	West Coast VBC 17's (CA)
						4	Aardwolf 18 S. Sound (PS)

SATURDAY MORNING POOL SCHEDULE

2/3 Matches, sets 1 & 2 capped at 27; set 3 to 15, no cap -- *Times Are Approximate*

4-Team Pool

TIME	PLAY	REF
9:00 AM	1 VS 3	2
10:00 AM	2 VS 4	1
11:00 AM	1 VS 4	3
12:00 PM	2 VS 3	1
1:00 PM	3 VS 4	2
2:00 PM	1 VS 2	4

3-Team Pools

TIME	PLAY	REF
9:00 AM	1 VS 3	2
10:00 AM	2 VS 3	1
11:00 AM	1 VS 2	3
12:00 PM	BREAK	
1:00 PM	Crossover Matches	
2:00 PM	Crossover Matches	

Crossover Matches for Pools A, B, C

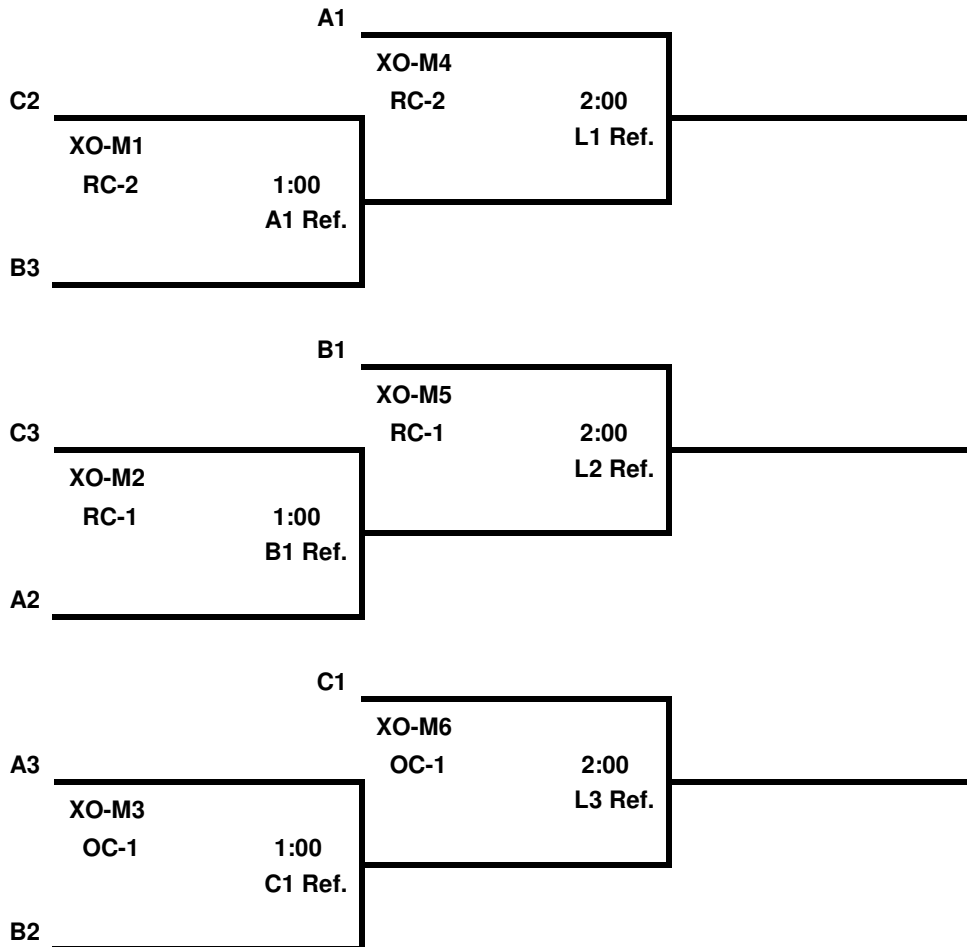

PLEASE CHECK THE NEXT PAGE FOR YOUR ROUND 2 ASSIGNMENTS

2018 NW Juniors Spring Classic Tournament

U18 ROUND 2 POOL PLAY

DIVISION 1

RED Court 2 POOL AA	
1	WXO-M4
2	WXO-M5
3	WXO-M6
4	D1

DIVISION 2

RED Court 1 POOL BB		ORANGE Court 1 POOL CC		ORANGE Court 3 POOL DD	
1	D2	1	LXO-M4	1	LXO-M6
2	LXO-M1	2	LXO-M3	2	LXO-M5
3	LXO-M2	3	D3	3	D4

SATURDAY PM & SUNDAY AM POOL SCHEDULE

2/3 Matches, sets 1 & 2 capped at 27; set 3 to 15, no cap -- Times Are Approximate

4-Team Pool

TIME	PLAY	REF
3:00 PM	1 VS 3	2
4:00 PM	2 VS 4	1

3-Team Pools

TIME	PLAY	REF
3:00 PM	1 VS 3	2

End of play Saturday

REMEMBER TO SPRING FORWARD FOR DAYLIGHT SAVINGS TIME

4-Team Pool

TIME	PLAY	REF
9:00 AM	1 VS 4	3
10:00 AM	2 VS 3	1
11:00 AM	3 VS 4	2
12:00 PM	1 VS 2	4

3-Team Pools

TIME	PLAY	REF
9:00 AM	2 VS 3	1
10:00 AM	1 VS 2	3
11:00 AM	Crossover Matches	
12:00 PM	Crossover Matches	

Crossover Matches for Pools BB, CC, DD

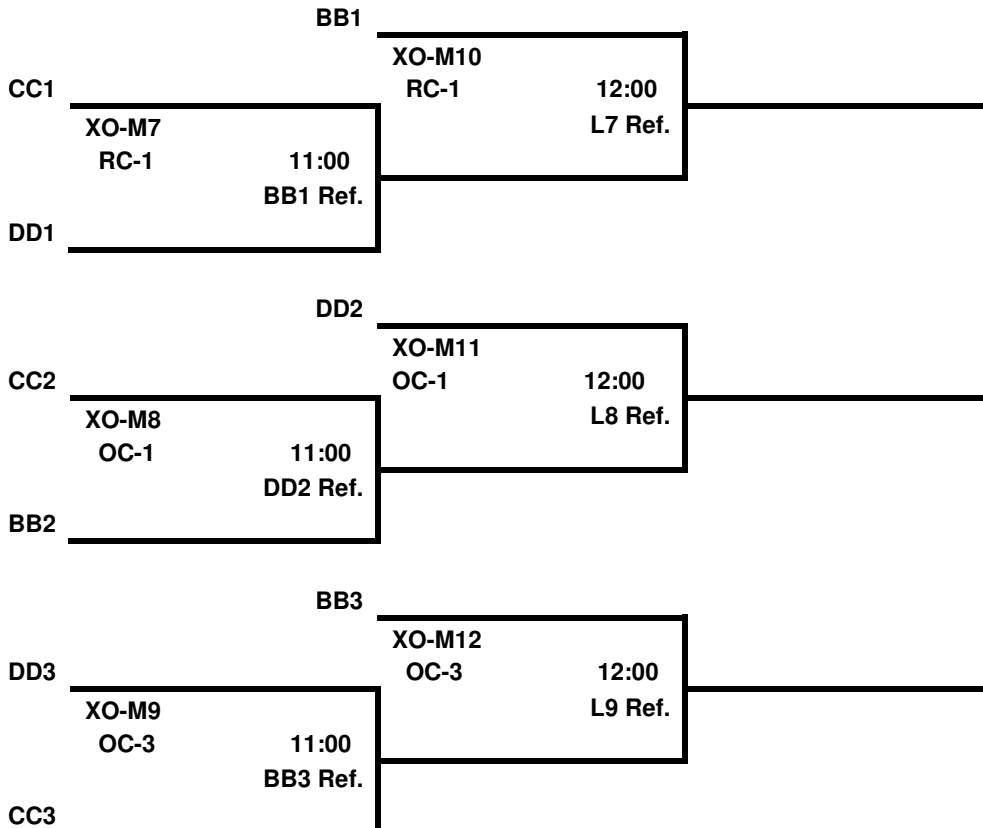

PLAYOFFS BEGIN AT APPROXIMATELY 1:30 PM

PLEASE CHECK NEXT PAGE FOR BRACKET PLACEMENT

2018 NW Juniors Spring Classic Tournament

U18 ROUND 3 PLAYOFFS

GOLD DIVISION

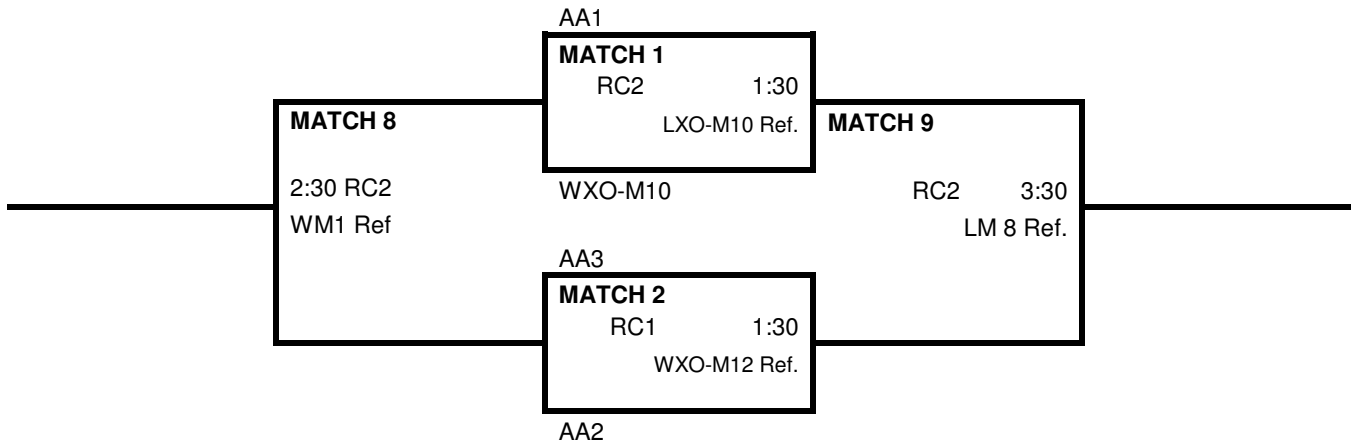

SILVER DIVISION

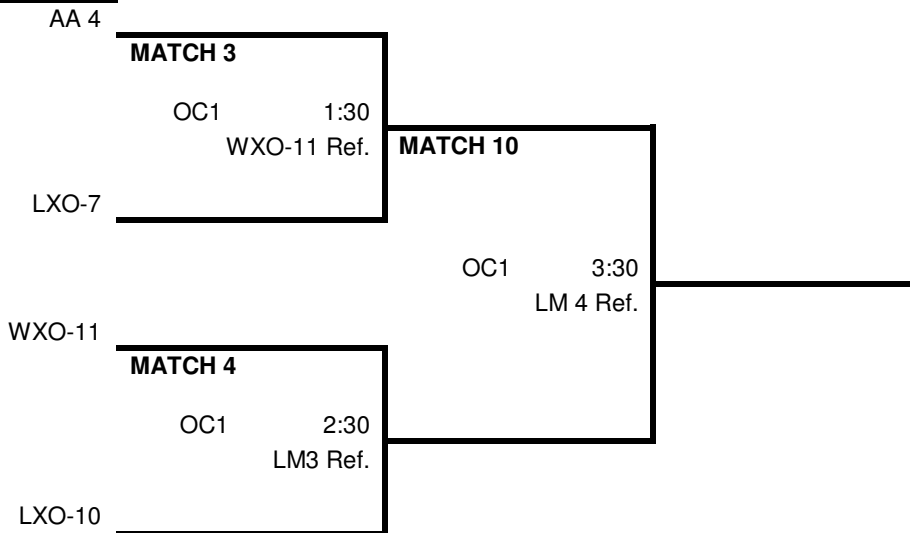

BRONZE DIVISION

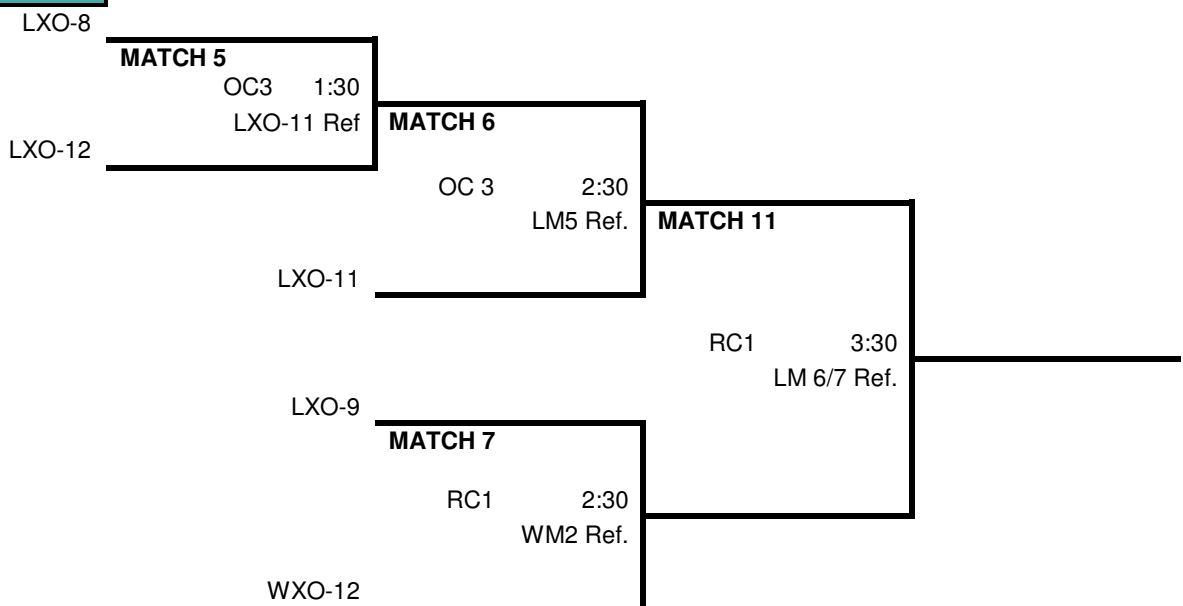

**U16
TOURNAMENT**

2018 NW Juniors Spring Classic Tournament

U16 ROUND 1 POOL PLAY

RED Court 3 POOL A		BLUE Court 1 POOL B		BLUE Court 3 POOL C	
1	PCVBA 16 National (PS)	1	OPVBC 16 Legacy (PS)	1	NW Jrs 16 Baden Blue (PS)
2	OPVBC 15 Kilakila (PS)	2	I Dig It 15 (CA)	2	Ducks 15 HP (CA)
3	206vb 15 Jhozlyn (PS)	3	206vb 15Chris (PS)	3	Aardwolf 15 S. Sound (PS)
4	NW Jrs. 15 Baden Blue (PS)				

SATURDAY MORNING POOL SCHEDULE

2/3 Matches, sets 1 & 2 capped at 27; set 3 to 15, no cap -- *Times Are Approximate*

4-Team Pool

TIME	PLAY	REF
9:00 AM	1 VS 3	2
10:00 AM	2 VS 4	1
11:00 AM	1 VS 4	3
12:00 PM	2 VS 3	1
1:00 PM	3 VS 4	2
2:00 PM	1 VS 2	4

3-Team Pools

TIME	PLAY	REF
9:00 AM	1 VS 3	2
10:00 AM	2 VS 3	1
11:00 AM	1 VS 2	3
12:00 PM	BREAK	
1:00 PM	Crossover Matches	
2:00 PM	Crossover Matches	

Crossover Matches for Pools B & C

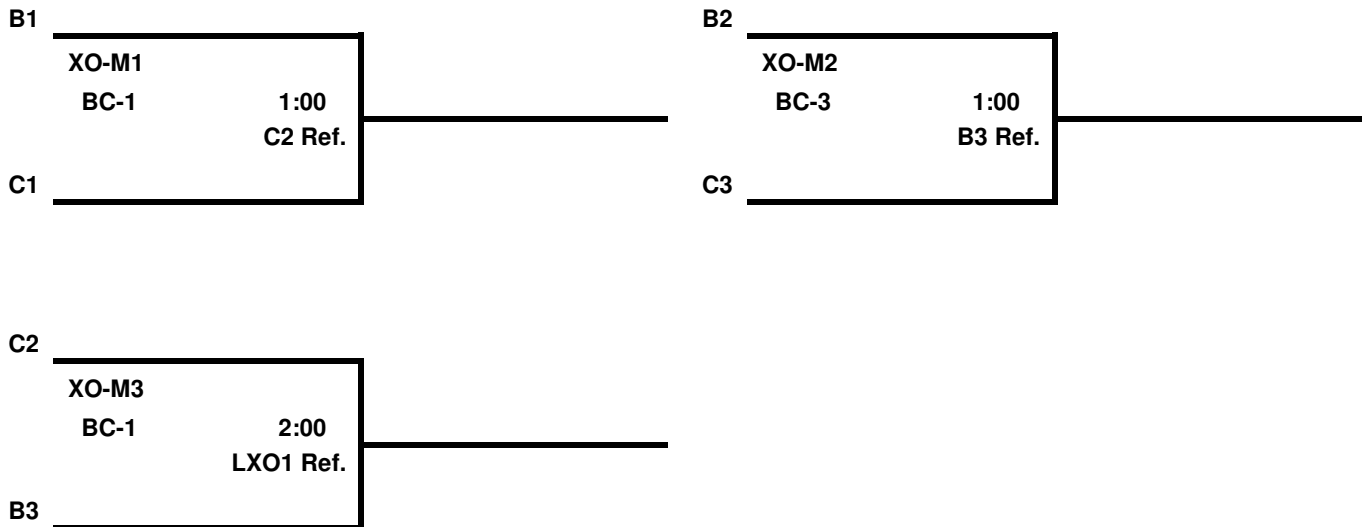

PLEASE CHECK NEXT PAGE FOR ROUND 2 ASSIGNMENTS

2018 NW Juniors Spring Classic Tournament

U16 ROUND 2 POOL PLAY

DIVISION 1

RED Court 3 POOL AA		BLUE Court 1 POOL BB	
1	A1	1	WXO-M1
2	LXO-M1	2	WXO-M3
3	WXO-M2	3	A2

DIVISION 2

BLUE Court 3 POOL CC	
1	A3
2	LXO-M3
3	LXO-M2
4	A4

SATURDAY PM & SUNDAY AM POOL SCHEDULE

2/3 Matches, sets 1 & 2 capped at 27; set 3 to 15, no cap -- *Times Are Approximate*

3-Team Pools

TIME	PLAY	REF
3:00 PM	1 VS 3	2

4-Team Pool

TIME	PLAY	REF
3:00 PM	1 VS 3	2
4:00 PM	2 VS 4	1

End of play Saturday

REMEMBER TO SPRING FORWARD FOR DAYLIGHT SAVINGS TIME

3-Team Pools

TIME	PLAY	REF
9:00 AM	2 VS 3	1
10:00 AM	1 VS 2	3
11:00 AM	Crossover Matches	
12:00 PM	Crossover Matches	

4-Team Pool

TIME	PLAY	REF
9:00 AM	1 VS 4	3
10:00 AM	2 VS 3	1
11:00 AM	3 VS 4	2
12:00 PM	1 VS 2	4

Crossover Matches for Pools AA & BB

AA2

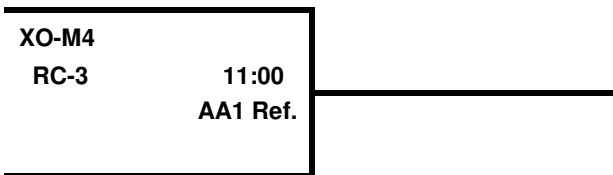

BB2

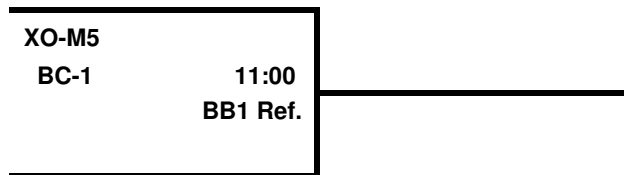

BB3

AA3

AA1

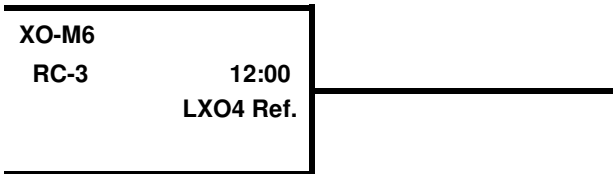

BB1

FOR PLAYOFFS: All playoff matches are 2/3 with no caps in any sets

- **GOLD DIVISION:** First place teams from Pools AA & BB and winners of Crossover Matches 4 & 5 will seed into a 4-team modified Double Elimination tournament.
- **SILVER DIVISION:** All teams from pool CC and losers of Crossover Matches 4 & 5 will seed into a 6-team Single Elimination tournament.

PLAYOFFS BEGIN AT APPROXIMATELY 1:30 PM

PLEASE CHECK NEXT PAGE FOR BRACKET PLACEMENT

2018 NW Juniors Spring Classic Tournament

U16 ROUND 3 PLAYOFFS

GOLD DIVISION

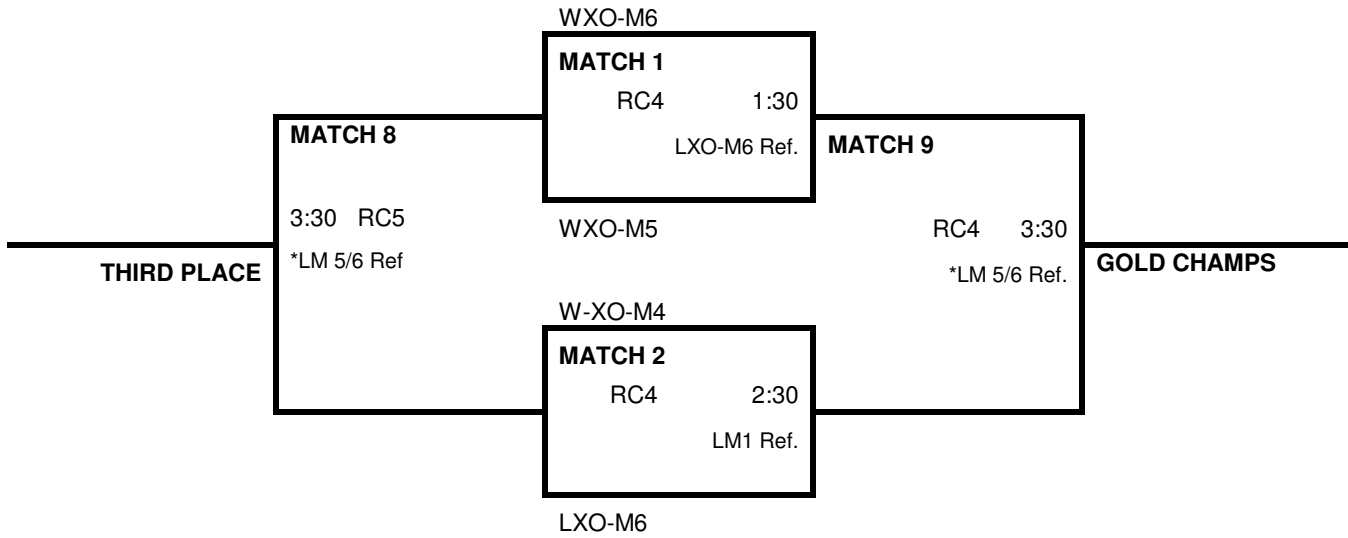

SILVER DIVISION

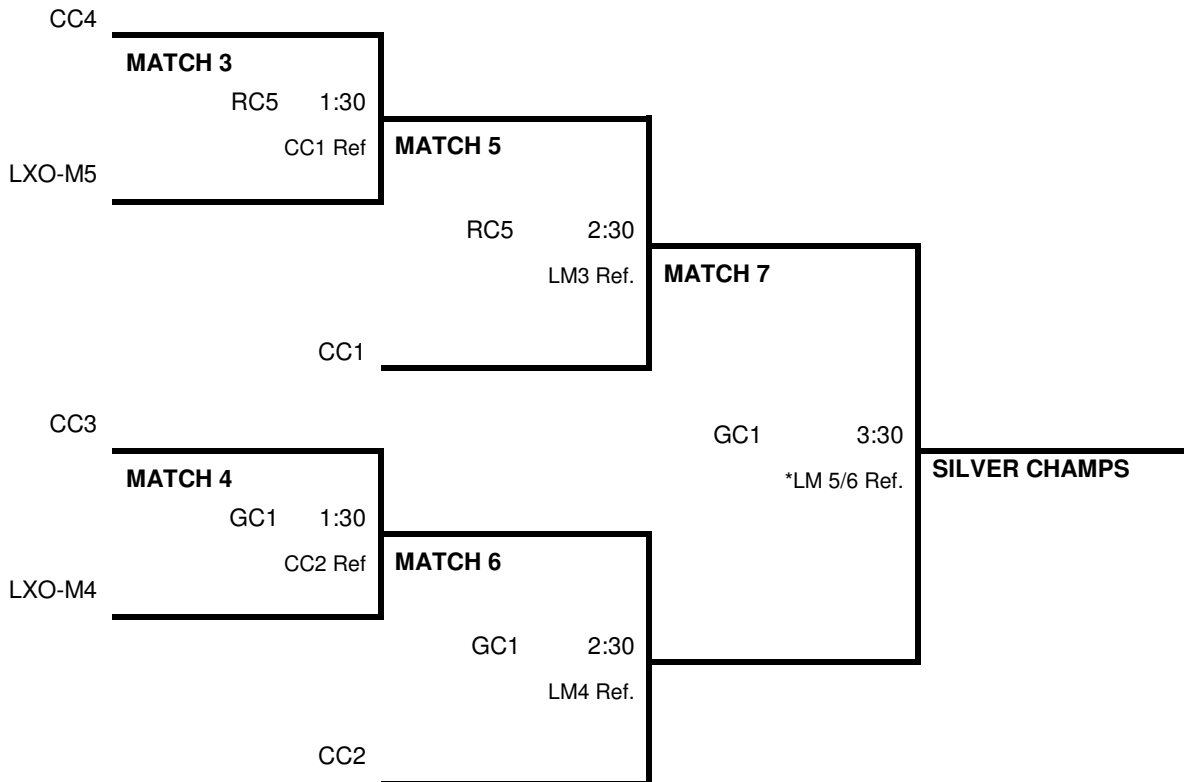

***Note: Match 5 & 6 Losers ref all 3:30 Matches (3 courts)**

2018 NW Juniors Spring Classic Tournament

**U14
TOURNAMENT**

2018 NW Juniors Spring Classic Tournament

U14 ROUND 1 POOL PLAY

RED Court 4 POOL A		RED Court 5 POOL B		GREEN Court 1 POOL C	
1	Agape 14-1 Gold (CE)	1	OPVBC 14 Apricity (PS)	1	NW 14 Baden Blue (PS)
2	NW 14 Baden Black (PS)	2	CCE 14-1 Black (CE)	2	OPVBC 14 Hype (PS)
3	Ducks 13A (CA)	3	NW 13 Baden Blue (PS)	3	CCE 14-2 Gold (CE)
4	NW 14 Baden Grey (PS)				

SATURDAY MORNING POOL SCHEDULE

2/3 Matches, sets 1 & 2 capped at 27; set 3 to 15, no cap -- *Times Are Approximate*

4-Team Pool

TIME	PLAY	REF
9:00 AM	1 VS 3	2
10:00 AM	2 VS 4	1
11:00 AM	1 VS 4	3
12:00 PM	2 VS 3	1
1:00 PM	3 VS 4	2
2:00 PM	1 VS 2	4

3-Team Pools

TIME	PLAY	REF
9:00 AM	1 VS 3	2
10:00 AM	2 VS 3	1
11:00 AM	1 VS 2	3
12:00 PM	BREAK	
1:00 PM	Crossover Matches	
2:00 PM	Crossover Matches	

Crossover Matches for Pools BB & CC

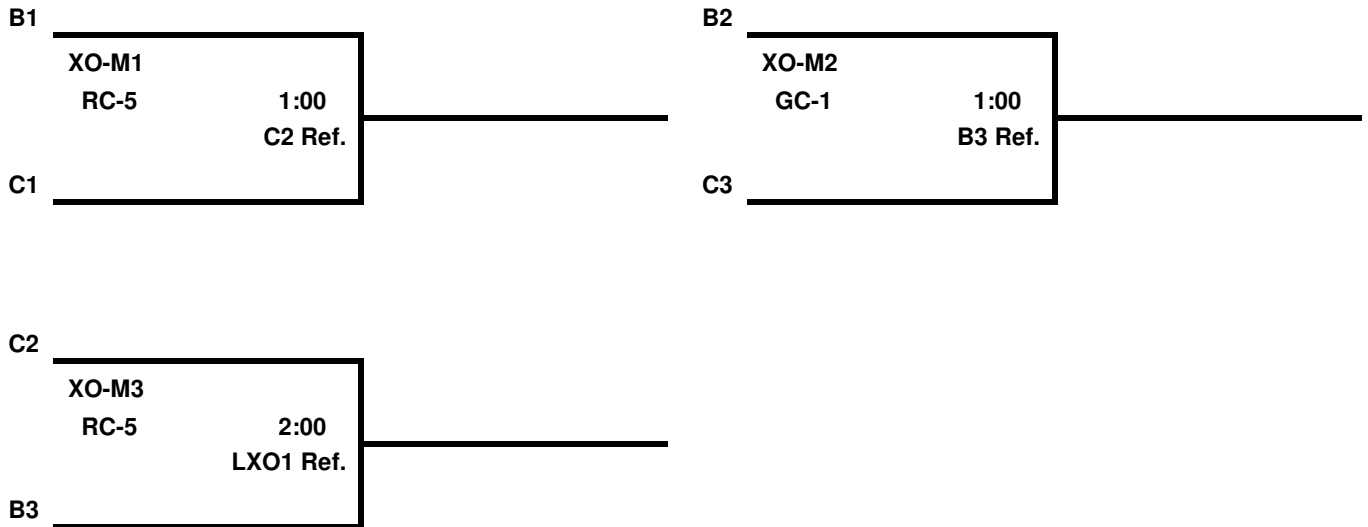

PLEASE CHECK NEXT PAGE FOR ROUND 2 ASSIGNMENTS

2018 NW Juniors Spring Classic Tournament

U14 ROUND 2 POOL PLAY

DIVISION 1

RED Court 4 POOL AA		RED Court 5 POOL BB	
1	A1	1	WXO-M1
2	LXO-M1	2	WXO-M3
3	WXO-M2	3	A2

DIVISION 2

GREEN Court 1 POOL CC	
1	A3
2	LXO-M3
3	LXO-M2
4	A4

SATURDAY PM & SUNDAY AM POOL SCHEDULE

2/3 Matches, sets 1 & 2 capped at 27; set 3 to 15, no cap -- Times Are Approximate

3-Team Pools

TIME	PLAY	REF
3:00 PM	1 VS 3	2

4-Team Pool

TIME	PLAY	REF
3:00 PM	1 VS 3	2
4:00 PM	2 VS 4	1

End of play Saturday

REMEMBER TO SPRING FORWARD FOR DAYLIGHT SAVINGS TIME

3-Team Pools

TIME	PLAY	REF
9:00 AM	2 VS 3	1
10:00 AM	1 VS 2	3
11:00 AM	Crossover Matches	
12:00 PM	Crossover Matches	

4-Team Pool

TIME	PLAY	REF
9:00 AM	1 VS 4	3
10:00 AM	2 VS 3	1
11:00 AM	3 VS 4	2
12:00 PM	1 VS 2	4

Crossover Matches for Pools AA & BB

AA3

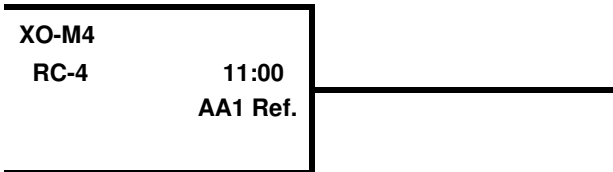

AA2

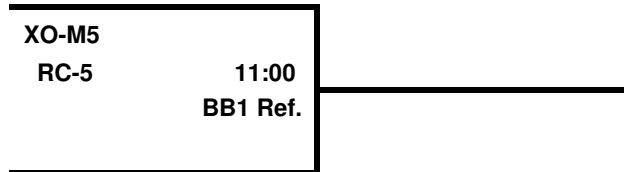

BB2

BB3

AA1

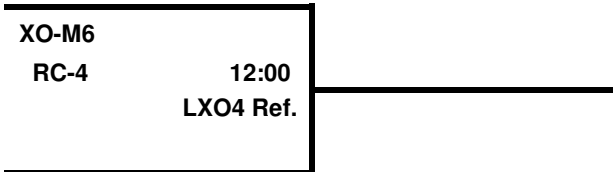

BB1

FOR PLAYOFFS: All playoff matches are 2/3 with no caps in any sets

- **GOLD DIVISION:** First place teams from Pools AA & BB and winners of Crossover Matches 4 & 5 will seed into a 4-team modified Double Elimination tournament.
- **SILVER DIVISION:** All teams from pool CC and losers of Crossover Matches 4 & 5 will seed into a 6-team Single Elimination tournament.

PLAYOFFS BEGIN AT APPROXIMATELY 1:30 PM
PLEASE CHECK NEXT PAGE FOR BRACKET PLACEMENT

2018 NW Juniors Spring Classic Tournament

U14 ROUND 3 PLAYOFFS

GOLD DIVISION

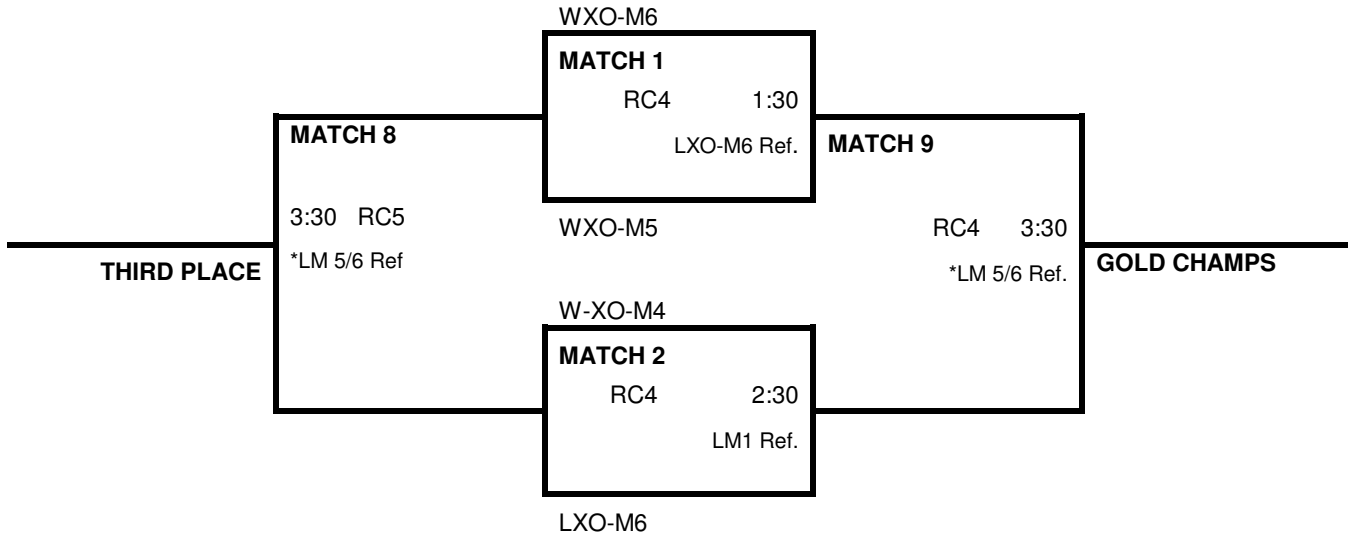

SILVER DIVISION

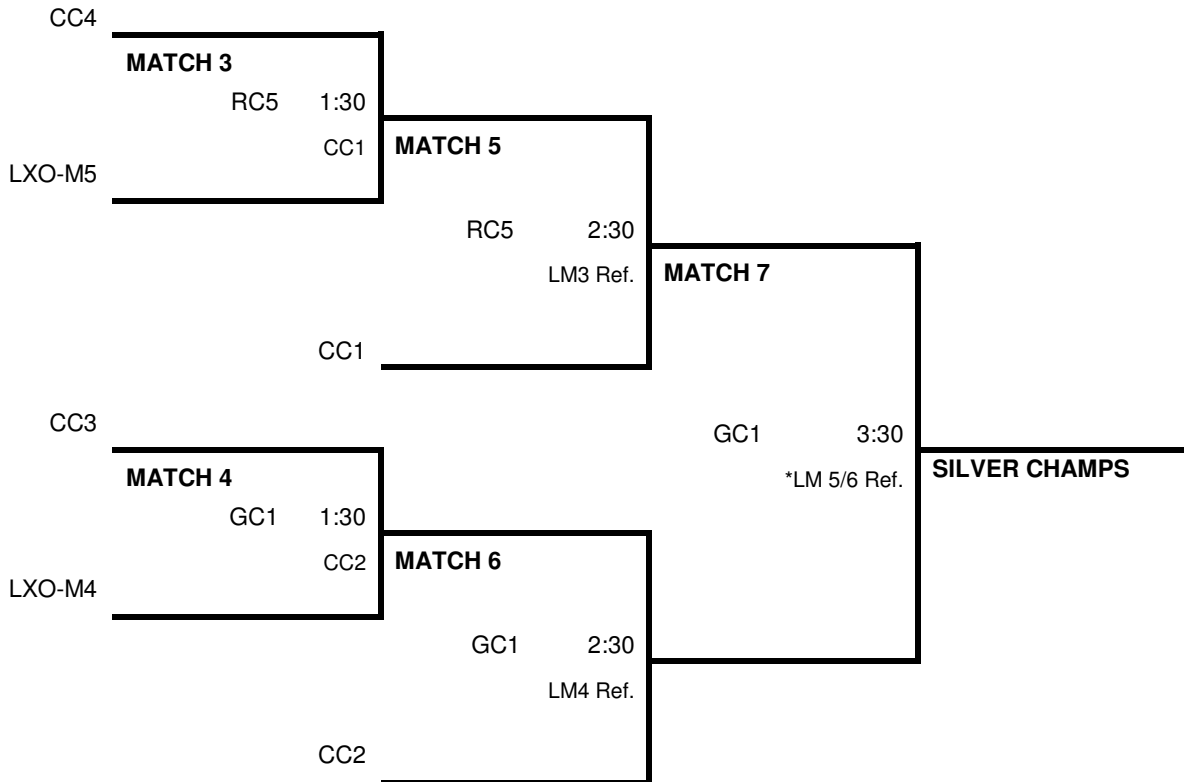

***Note: Match 5 & 6 Losers ref all 3:30 Matches (3 courts)**

2018 NW Juniors Spring Classic Tournament



APRIL 3RD BEACH VOLLEYBALL TRAINING BEGINS!

AVP & USAV Beach Tournaments Start in May So you have to start training with us in April!

NW Juniors is proud to offer beach volleyball training again this year as we begin our second season at Bottega Beach. We have expanded all of our beach programs and have a busy tournament schedule. Whether you are a first time beach player or have been playing for a few years and want to Qualify for Nationals (AVP First and/or USAV Beach) – we have training that will challenge you to be a better beach and indoor player. Come train at our private 6-court facility with our great coaching staff.

**Must have USAV membership to participate.*



USA Beach Volleyball.

WE TRAIN HERE:

Bottega Beach/Bottega Fitness
16720 State Route 9
Snohomish, WA 98296

Questions: info@volleyballnw.com

Tony Miranda: 206-550-6671 X 102

www.nwjuniors.org/beachclub

Beach Volleyball Training!

Private 6-Court Facility
and indoor gym

APRIL & MAY TRAINING

Sign up for one month or both! Pick FIVE 2-hour training sessions that fit your schedule. Training is offered T/W/TH afternoons (after 5:30 PM) and some weekends.

Set your own schedule!

Cost: \$250/month

Host Site for AVP,
USAV Beach
Qualifiers, AVP First
Qualifiers, HP Tryouts,
AVP Next Tournament
Series

Beach IMPACT and
AVP Academy
Certified Coaches that
still play the game

Private Trainers to
supplement volleyball
training

2018 NW Juniors Spring Classic Tournament

2018 Beach Schedule

These are our confirmed dates for tournaments. Schedule is subject to change. Check our site for the most up to date information and to register for our tournaments: www.nwjuniors.org/2018tournaments

We have a few other weekends that we will be adding events. All tournaments are Doubles unless otherwise indicated.

Date	Event	Location	Ages/Divisions	Cost
Sat-Sun May 12-13	USAV Junior Beach Tour Qualifier	Bottega Beach Willis Tucker	U14 & U16 Girls (Bottega) U12 & U18 Girls, All Boys (WT)	TBA
Sat, May 19	NW Juniors Grand Prix Series #1	Alki Beach	U12 & U14	\$75 per team
Sun, May 20	NW Juniors Grand Prix Series #1	Alki Beach	U16 & U18	\$75 per team
Fri, May 25	AVP First Qualifier #1 NW Grand Prix Series #2	Bottega Beach	PM WAVE: Girls U12 & 14	\$80 per team
Mon, May 28	AVP First Qualifier #1 NW Grand Prix Series #2	Bottega Beach	AM WAVE: Boys U14 & 18 PM WAVE: Girls U16 & 18	\$80 per team
June 2 & 3	Puget Sound Region will host their Beach HP tryouts at Bottega Beach. Check PSR region website for details			
Wed, June 6	AVP First Qualifier #2	Bottega Beach	PM: Girls U12 & 14	\$80 per team
Wed, June 13	AVP First Qualifier #3	Bottega Beach	PM: Girls U16 & 18	\$80 per team
Wed, June 27	AVP First Qualifier #4	Bottega Beach	AM: Girls U16 & U18 PM: Girls U12 & U14	\$80 per team
Sat, June 16	Akamai Beach Tour www.akamaibeachtour.com	Bottega Beach	Girls U16 & U18	TBA
		Alki Beach	Girls U12 & U14	TBA
Sun, June 17	Father-Daughter Doubles Family Fours	Bottega Beach & Alki Beach	Doubles: U14/U18 (player age)	\$75 per team
			Family 4's	\$100 per team
Thurs, June 21	The AVP will host a Women's Qualifier for the AVP Seattle Open at Bottega Beach. Admission is FREE			
Fri-Sun, June 22-24	AVP Seattle Open AVP First Gold Event (concurrent)	Lk. Sammamish State Park	Must Qualify Through your beach club	TBA
Sat, June 30	AVP First Qualifier #5	Bottega Beach	AM: Girls U12 & U14 PM: Boys U14 & U18	\$80 per team
Sun, July 1	AVP First Qualifier #5	Bottega Beach	AM: Girls U16 & U18	\$80 per team
Sat, July 7	USAV Beach Regional Qualifier (1 bid per age group)	Bottega Beach	Girls: U12 Boys: U14/U18	TBA
Sun, July 8		Bottega Beach & Alki Beach	Girls: U14/16/18	
Sat, July 14	AVP First Qualifier #6 (2019 Season points)	Bottega Beach	AM: Girls U12 & U14 PM: Boys U14 & U18	\$80 per team
Sun, July 15	AVP First Qualifier #6 (2019)	Bottega Beach	AM: Girls U16 & U18	\$80 per team
Sat, July 21	Queen of the Beach	Alki Beach	U12 /14/16/18 Girls	\$30 per player
Sat, July 21	AVP First Qualifier #6 (2019 Season points)	Bottega Beach	AM: Girls U12 & U14 PM: Boys U14 & U18	\$80 per team
Sun, July 22	AVP First Qualifier #6 (2019)	Bottega Beach	AM: Girls U16 & U18	\$80 per team
Sat, July 28	Parent-Child Doubles	Bottega Beach	Based on player Age: 14 Under / 15 Older	\$80 per team
Sun, July 29	Family Fours	Bottega Beach	Max: 2 adults	\$100 per team
Sat, August 4	AVP First Qualifier #7 (2019 Season points)	Bottega Beach	AM: Girls U12 & U14 PM: Boys U14 & U18	\$80 per team
Sun, August 5	AVP First Qualifier #7 (2019)	Bottega Beach	AM: Girls U16 & U18	\$80 per team
Sat, Aug 18	High School Fours	Bottega Beach: 4A/3A Division 2A/1A/B Division		\$100 Per team
Sun, Aug 19	Doubles Beach Party	Bottega Beach: AM: U16/18 PM: U12/14		\$80 per team